

Premium Booth 3mW x 3mD One side open

SD-B-9
3mW x 3mD x 3.5mH

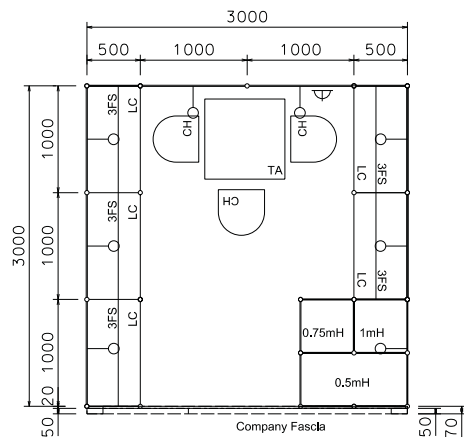

PLAN

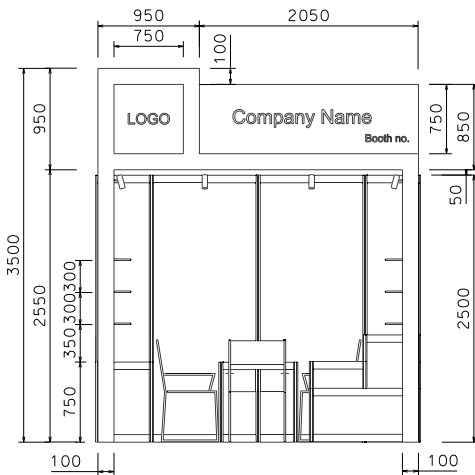



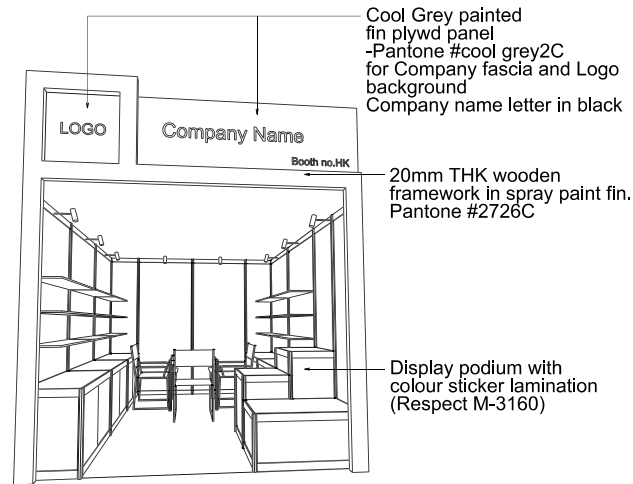







FRONT ELEVATION



PERSPECTIVE N.T.S.



COLOUR PERSPECTIVE N.T.S.

| BOOTH SPECIFICATION | | QTY |
|---------------------------------------------------------------------------------------|---------------------------------------------------------------------------|-----|
|  | Lockable cabinet in purple-blue sticker lamination (1mL x 0.5mD x 0.75mH) | 5 |
|  | Wooden shelf (flat) (1mL x 0.3mD) | 15 |
|  | 0.5mX 0.5mX 1mH display podium in blue sticker lamination | 1 |
|  | 0.5mX 0.5mX 0.75mH display podium in blue sticker lamination | 1 |
|  | 1mX 0.5mX 0.5mH display podium in blue sticker lamination | 1 |
|  | Square meeting table (0.7m X0.7m x 0.75mH) | 1 |
|  | Black leather chair | 3 |
|  | Longarmed spotlight w/23 watt energy saving lamp (yellow) | 8 |
|  | 500w Square pin power socket | 1 |
|  | Company logo | 1 |

*The Hong Kong Trade Development Council reserves the right to change the configuration if necessary.

*如有需要，香港貿易發展局有權更改展台結構。

Premium Booth 3mW x 3mD Left side Corner booth

SD-B-9-L_Cnr
3mW x 3mD x 3.5mH

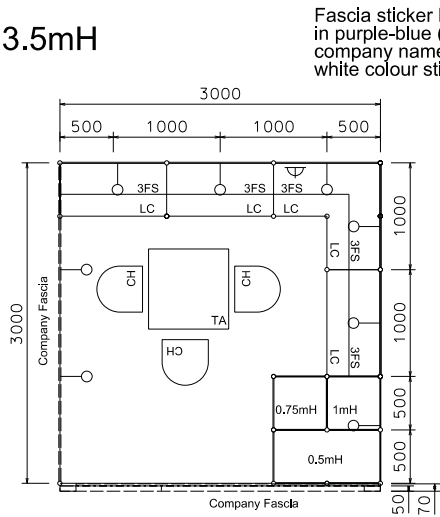

PLAN

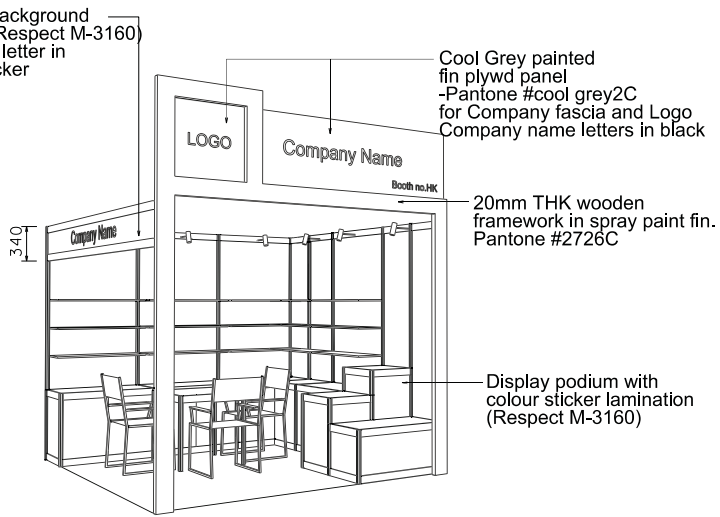

PERSPECTIVE N.T.S

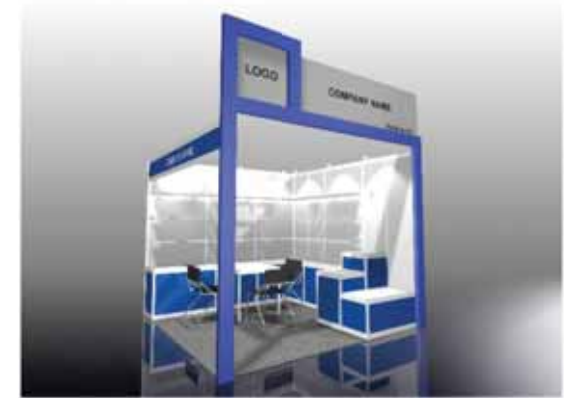

COLOUR PERSPECTIVE N.T.S

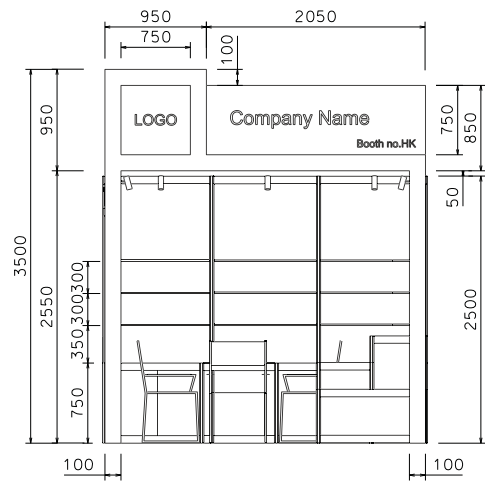

FRONT ELEVATION

| BOOTH SPECIFICATION | | QTY |
|---------------------|---------------------------------------------------------------------------|-----|
| | Lockable cabinet in purple-blue sticker lamination (1mL x 0.5mD x 0.75mH) | 4.5 |
| | Wooden shelf (flat) (1mL x 0.3mD) | 15 |
| | 0.5mX 0.5mX 1mH display podium in blue sticker lamination | 1 |
| | 0.5mX 0.5mX 0.75mH display podium in blue sticker lamination | 1 |
| | 1mX 0.5mX 0.5mH display podium in blue sticker lamination | 1 |
| | Square meeting table (0.7m X0.7m x 0.75mH) | 1 |
| | Black leather chair | 3 |
| | Longarmed spotlight w/23 watt energy saving lamp (yellow) | 8 |
| | 500w Square pin power socket | 1 |
| | Company logo | 1 |

FILE PATH - L:\Local Fair Premium Booth 2011\SD\SD-Layouts\SD-B layout\SD-B-2d\eyout.dgn

*The Hong Kong Trade Development Council reserves the right to change the configuration if necessary.
*如有需要，香港貿易發展局有權更改展台結構。

Premium Booth 3mW x 3mD Right side Corner booth

SD-B-9-R Cnr
3mW x 3mD x 3.5mH

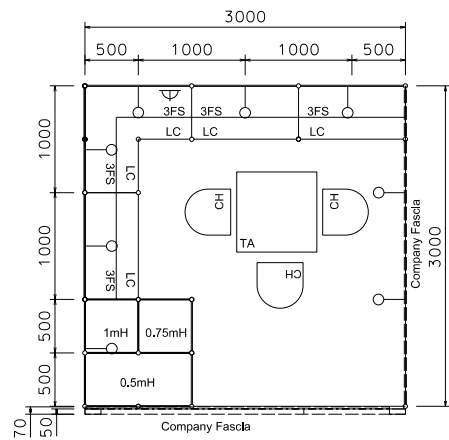

PLAN

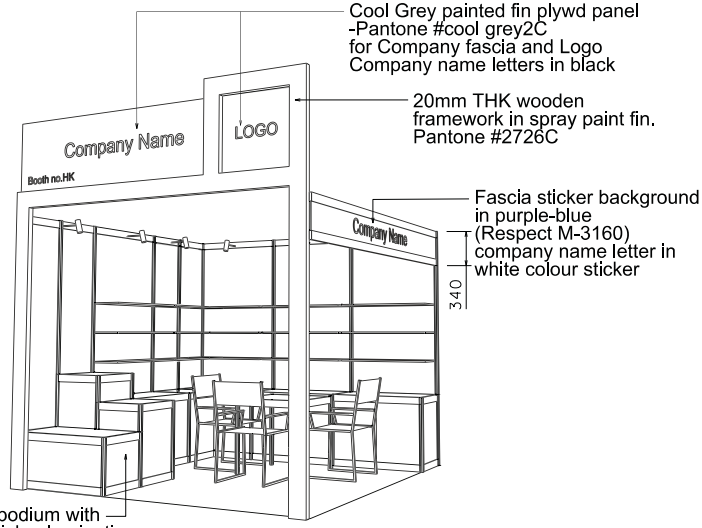

PERSPECTIVE N.T.S

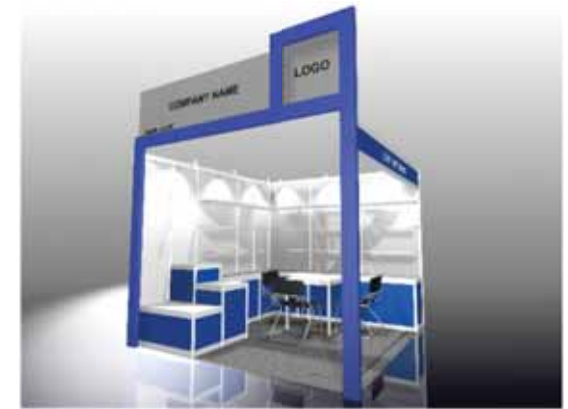

COLOUR PERSPECTIVE N.T.S

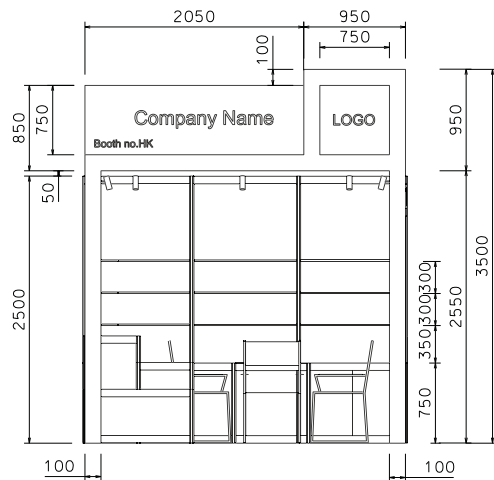

FRONT ELEVATION

| BOOTH SPECIFICATION | | QTY |
|---------------------|---------------------------------------------------------------------------|-----|
| | Lockable cabinet in purple-blue sticker lamination (1mL x 0.5mD x 0.75mH) | 4.5 |
| | Wooden shelf (flat) (1mL x 0.3mD) | 15 |
| | 0.5mX 0.5mX 1mH display podium in blue sticker lamination | 1 |
| | 0.5mX 0.5mX 0.75mH display podium in blue sticker lamination | 1 |
| | 1mX 0.5mX 0.5mH display podium in blue sticker lamination | 1 |
| | Square meeting table (0.7m X0.7m x 0.75mH) | 1 |
| | Black leather chair | 3 |
| | Longarmed spotlight w/23 watt energy saving lamp (yellow) | 8 |
| | 500w Square pin power socket | 1 |
| | Company logo | 1 |

*The Hong Kong Trade Development Council reserves the right to change the configuration if necessary.

*如有需要，香港貿易發展局有權更改展台結構。

Premium Booth 5mW x 3mD One side open

SD-B-W15

5mW x 3mD x 3.5mH

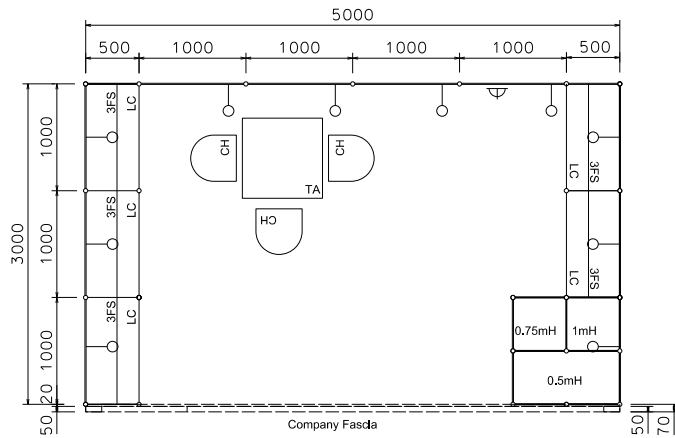

PLAN

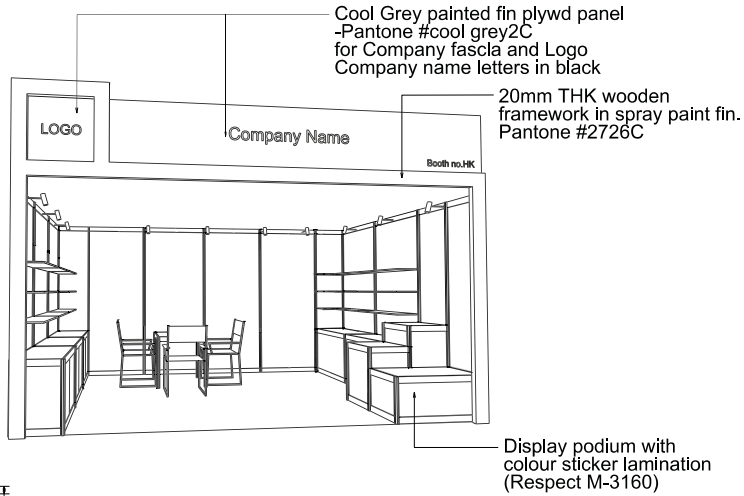

PERSPECTIVE N.T.S



COLOUR PERSPECTIVE N.T.S

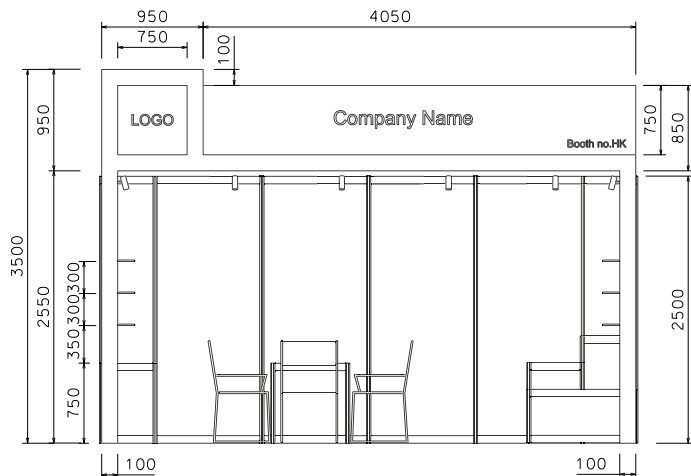

FRONT ELEVATION

| BOOTH SPECIFICATION | | QTY |
|---------------------|---------------------------------------------------------------------------|-----|
| | Lockable cabinet in purple-blue sticker lamination (1mL x 0.5mD x 0.75mH) | 5 |
| | Wooden shelf (flat) (1mL x 0.3mD) | 15 |
| | 0.5mX 0.5mX 1mH display podium in blue sticker lamination | 1 |
| | 0.5mX 0.5mX 0.75mH display podium in blue sticker lamination | 1 |
| | 1mX 0.5mX 0.5mH display podium in blue sticker lamination | 1 |
| | Square meeting table (0.7m X0.7m x 0.75mH) | 1 |
| | Black leather chair | 3 |
| | Longarmed spotlight w/23 watt energy saving lamp (yellow) | 10 |
| | 500w Square pin power socket | 1 |
| | Company logo | 1 |

*The Hong Kong Trade Development Council reserves the right to change the configuration if necessary.

*如有需要，香港貿易發展局有權更改展台結構。

Premium Booth 5mW x 3mD Left side Corner booth

SD-B-W15-L_Cnr
5mW x 3mD x 3.5mH

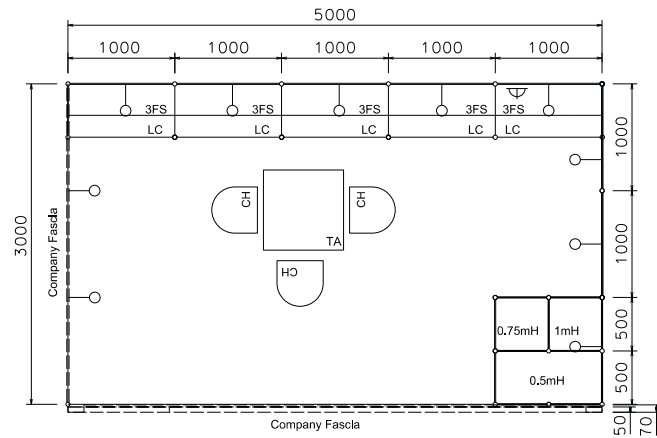

Fascia sticker background in purple-blue (Respect M-3160)
company name letter in white colour sticker

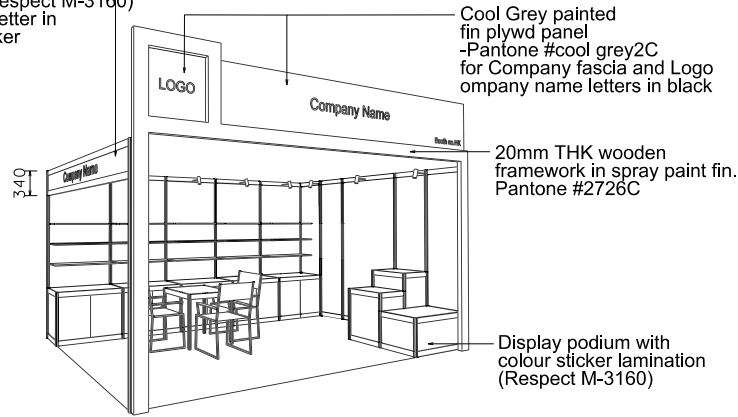

COLOUR PERSPECTIVE N.T.S

PLAN

PERSPECTIVE N.T.S

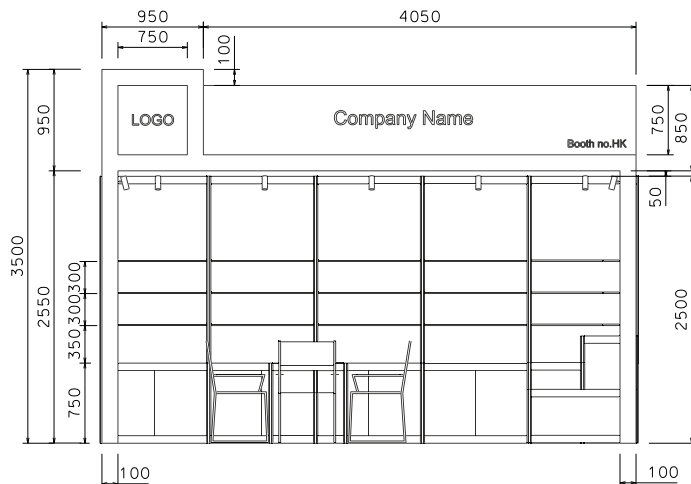

FRONT ELEVATION

| BOOTH SPECIFICATION | | QTY |
|---------------------|---------------------------------------------------------------------------|-----|
| | Lockable cabinet in purple-blue sticker lamination (1mL x 0.5mD x 0.75mH) | 5 |
| | Wooden shelf (flat) (1mL x 0.3mD) | 15 |
| | 0.5mX 0.5mX 1mH display podium in blue sticker lamination | 1 |
| | 0.5mX 0.5mX 0.75mH display podium in blue sticker lamination | 1 |
| | 1mX 0.5mX 0.5mH display podium in blue sticker lamination | 1 |
| | Square meeting table (0.7m X0.7m x 0.75mH) | 1 |
| | Black leather chair | 3 |
| | Longarmed spotlight w/23 watt energy saving lamp (yellow) | 10 |
| | 500w Square pin power socket | 1 |
| | Company logo | 1 |

FILE PATH: L:\Local Fair\ Premium Booth 2011\SD\SD-L\layouts\SD-B layout.dgn

*The Hong Kong Trade Development Council reserves the right to change the configuration if necessary.

*如有需要，香港貿易發展局有權更改展台結構。

Premium Booth 5mW x 3mD Right side Corner booth

SD-B-W15-R_Cnr
5mW x 3mD x 3.5mH

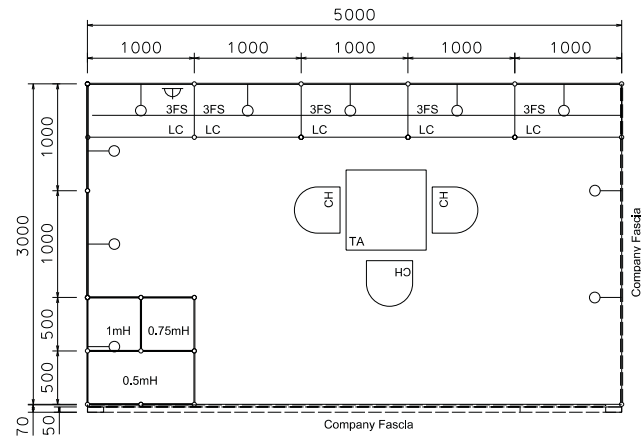

PLAN

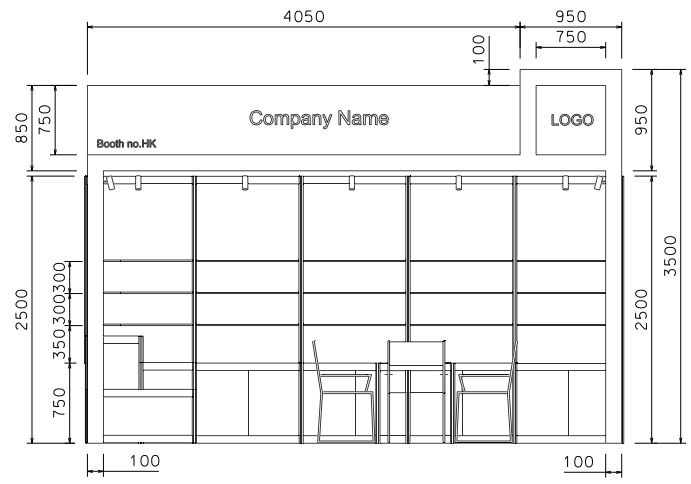

FRONT ELEVATION

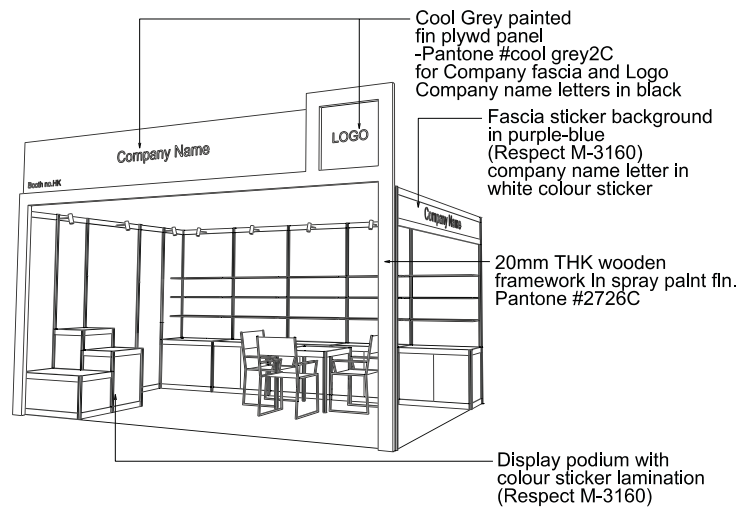

PERSPECTIVE N.T.S

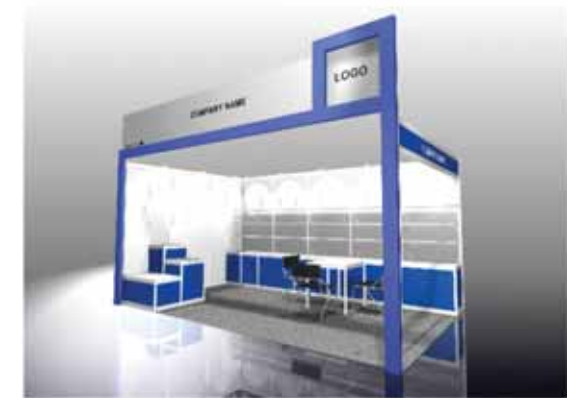

COLOUR PERSPECTIVE N.T.S

| BOOTH SPECIFICATION | | QTY |
|---------------------|---------------------------------------------------------------------------|-----|
| | Lockable cabinet in purple-blue sticker lamination (1mL x 0.5mD x 0.75mH) | 5 |
| | Wooden shelf (flat) (1mL x 0.3mD) | 15 |
| | 0.5mX 0.5mX 1mH display podium in blue sticker lamination | 1 |
| | 0.5mX 0.5mX 0.75mH display podium in blue sticker lamination | 1 |
| | 1mX 0.5mX 0.5mH display podium in blue sticker lamination | 1 |
| | Square meeting table (0.7m X0.7m x 0.75mH) | 1 |
| | Black leather chair | 3 |
| | Longarmed spotlight w/23 watt energy saving lamp (yellow) | 10 |
| | 500w Square pin power socket | 1 |
| | Company logo | 1 |

FILE PATH: L:\Local Fair\Premium Booth 2011\SD\SD-Layouts\SD-B layout\SD-B-2d\layout.dgn

*The Hong Kong Trade Development Council reserves the right to change the configuration if necessary.
*如有需要，香港貿易發展局有權更改展台結構。

Premium Booth 6mW x 3mD One side open

SD-B-18 _ 6mW x 3mD x 3.5mH

20mm THK wooden
framework in spray paint fin.
Pantone #2726C

Cool Grey painted fin plywd panel
-Pantone #cool grey2C
for Company fascia and Logo
Company name letters in black

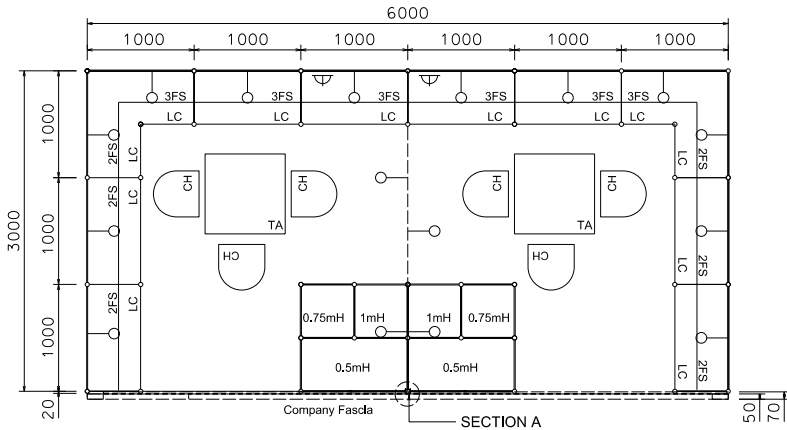
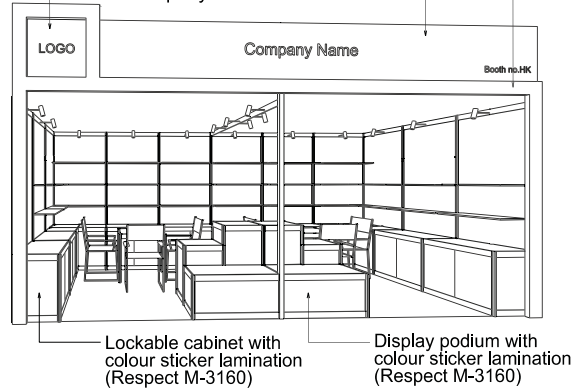

PLAN

PERSPECTIVE N.T.S

COLOUR PERSPECTIVE N.T.S

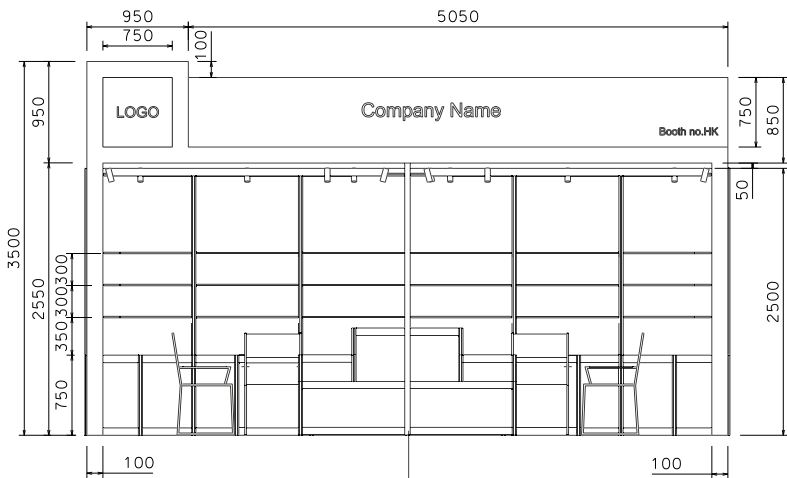

FRONT ELEVATION

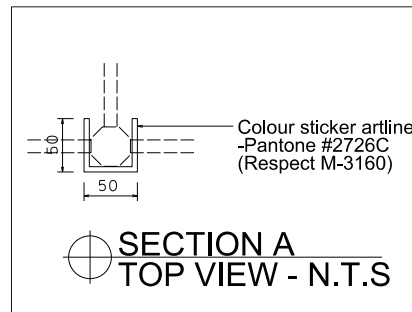

| BOOTH SPECIFICATION | | QTY |
|---------------------|---------------------------------------------------------------------------|-----|
| | Lockable cabinet in purple-blue sticker lamination (1mL x 0.5mD x 0.75mH) | 11 |
| | Wooden shelf (flat) (1mL x 0.3mD) | 30 |
| | 0.5mX 0.5mX 1mH display podium in blue sticker lamination | 2 |
| | 0.5mX 0.5mX 0.75mH display podium in blue sticker lamination | 2 |
| | 0.5mX 1mX 0.5mH display podium in blue sticker lamination | 2 |
| | Square meeting table (0.7m X 0.7m x 0.75mH) | 2 |
| | Black leather chair | 6 |
| | Longarmed spotlight w/23 watt energy saving lamp (yellow) | 16 |
| | 500w Square pin power socket | 2 |
| | Company logo | 1 |

FILE PATH - L:\Local Fair Premium Booth 2011\SD-B-Layouts\SD-B layout\SD-B-2d\layout.dgn

*The Hong Kong Trade Development Council reserves the right to change the configuration if necessary.

*如有需要，香港貿易發展局有權更改展台結構。

Premium Booth 6mW x 3mD Left Corner Booth

SD-B-18 _L-Cnr _6mW x 3mD x 3.5mH

Fascia sticker background in purple-blue (Respect M-3160) company name letter in white colour sticker

Cool Grey painted fin plywd panel -Pantone #cool grey2C for Company fascia and Logo Company name letters in black

20mm THK wooden framework in spray paint fin. Pantone #2726C

Lockable cabinet with colour sticker lamination (Respect M-3160)
Display podium with colour sticker lamination (Respect M-3160)

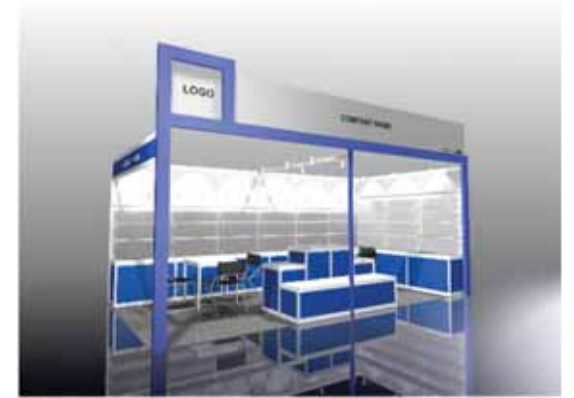
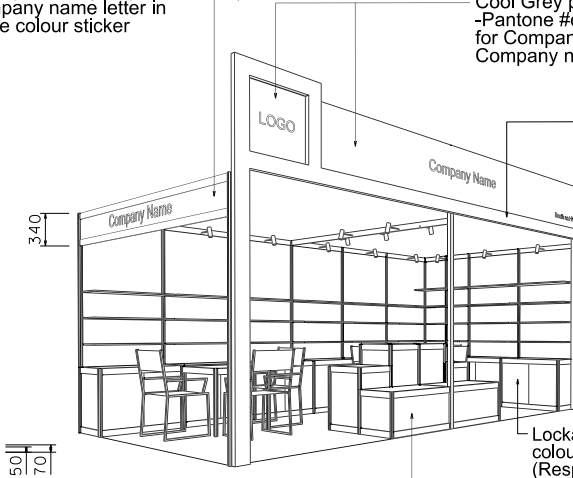
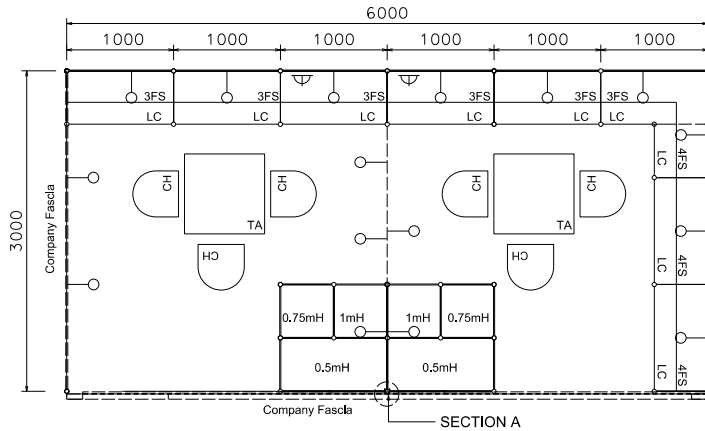

PLAN





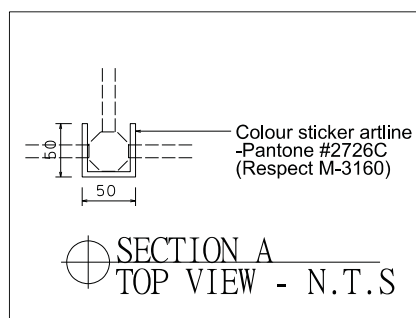
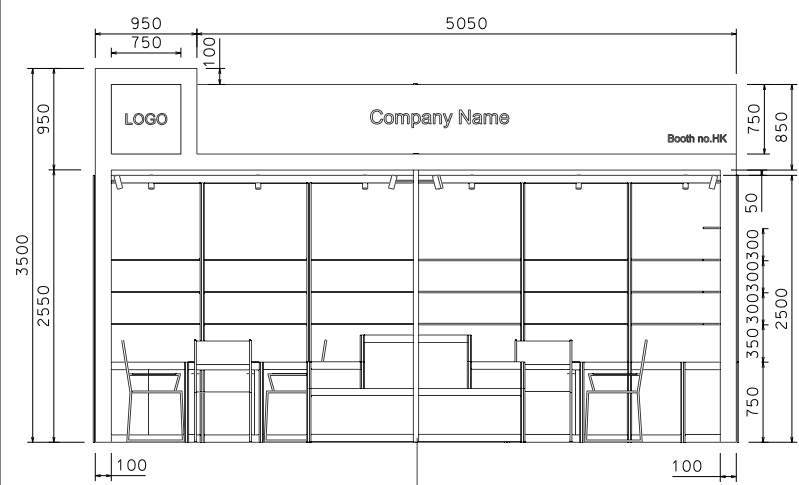





PERSPECTIVE N.T.S

COLOUR PERSPECTIVE N.T.S



FRONT ELEVATION

SECTION A TOP VIEW - N.T.S

| BOOTH SPECIFICATION | | QTY |
|---------------------------------------------------------------------------------------|---------------------------------------------------------------------------|-----|
|  | Lockable cabinet in purple-blue sticker lamination (1mL x 0.5mD x 0.75mH) | 8.5 |
|  | Wooden shelf (flat) (1mL x 0.3mD) | 30 |
|  | 0.5mX 0.5mX 1mH display podium in blue sticker lamination | 2 |
|  | 0.5mX 0.5mX 0.75mH display podium in blue sticker lamination | 2 |
|  | 1mX 0.5mX 0.5mH display podium in blue sticker lamination | 2 |
|  | Square meeting table (0.7m X 0.7m x 0.75mH) | 2 |
|  | Black leather chair | 6 |
|  | Longarmed spotlight w/23 watt energy saving lamp (yellow) | 16 |
|  | 500w Square pin power socket | 2 |
|  | Company logo | 1 |

FILE PATH - L:\Local Fair Premium Booth 2011\SD\SD-1-Layouts\SD-B layout\SD-B-2d\layout.dgn

*The Hong Kong Trade Development Council reserves the right to change the configuration if necessary.

*如有需要，香港貿易發展局有權更改展台結構。

Premium Booth 6mW x 3mD Right Corner Booth

SD-B-18_R-Cnr_6mW x 3mD x 3.5mH

Cool Grey painted fin plywd panel
-Pantone #cool grey2C
for Company fascia and Logo
Company name letters in black

Fascia sticker background
in purple-blue (Respect M-3160)
company name letter in
white colour sticker

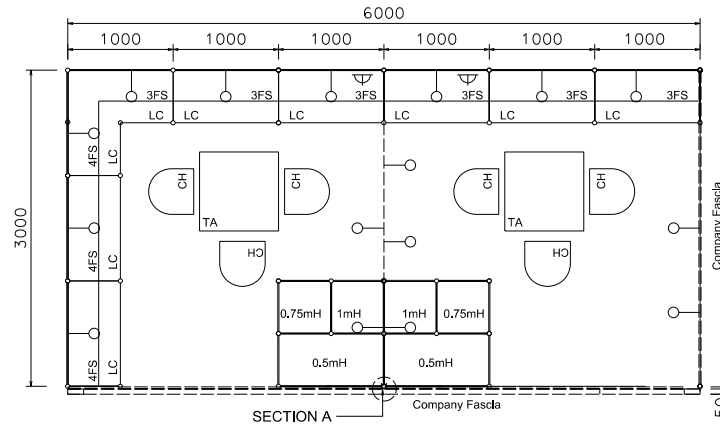

PLAN

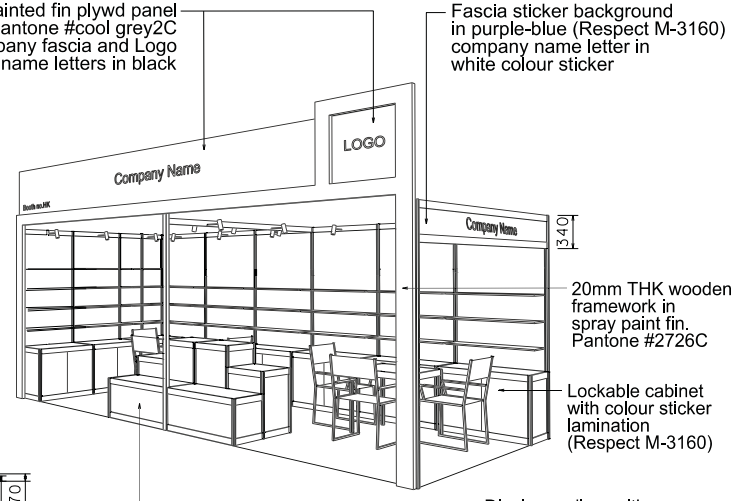

PERSPECTIVE N.T.S

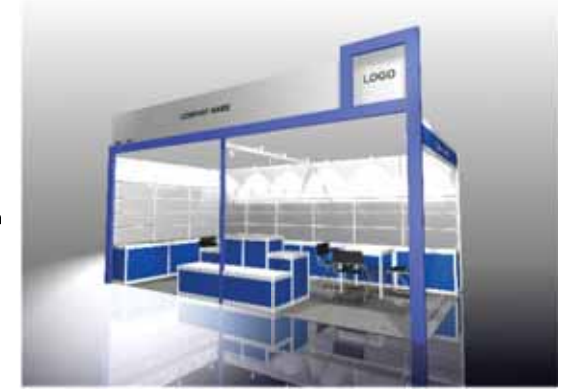

COLOUR PERSPECTIVE N.T.S

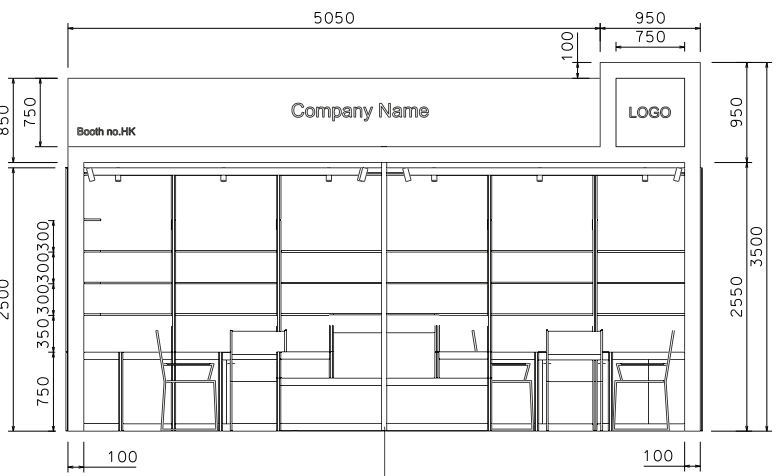

FRONT ELEVATION

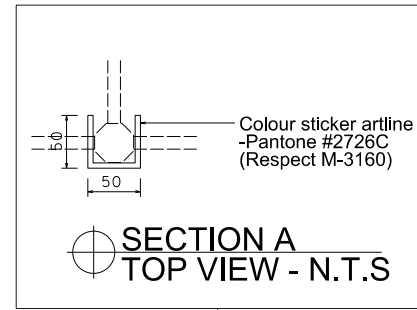

SECTION A
TOP VIEW - N.T.S

| BOOTH SPECIFICATION | | QTY |
|---------------------|---------------------------------------------------------------------------|-----|
| | Lockable cabinet in purple-blue sticker lamination (1mL x 0.5mD x 0.75mH) | 8.5 |
| | Wooden shelf (flat) (1mL x 0.3mD) | 30 |
| | 0.5mX 0.5mX 1mH display podium in blue sticker lamination | 2 |
| | 0.5mX 0.5mX 0.75mH display podium in blue sticker lamination | 2 |
| | 1mX 0.5mX 0.5mH display podium in blue sticker lamination | 2 |
| | Square meeting table (0.7m X0.7m x 0.75mH) | 2 |
| | Black leather chair | 6 |
| | Longarmed spotlight w/23 watt energy saving lamp (yellow) | 16 |
| | 500w Square pin power socket | 2 |
| | Company logo | 1 |

FILE PATH : L:\Local Fair\Premium Booth_2011\SD\SD-LAYOUTS\SD-B layout\SD-B-2d\layout.dgn

NOTES

REVISION

DATE

20-01-2010

TITLE

PROJECT

SHEET

*The Hong Kong Trade Development Council reserves the right to change the configuration if necessary.

*如有需要，香港貿易發展局有權更改展台結構。

Premium Booth 9mW x 3mD 3 SIDES OPEN

SD-B-27_ 9mW x 3mD x 3.5mH

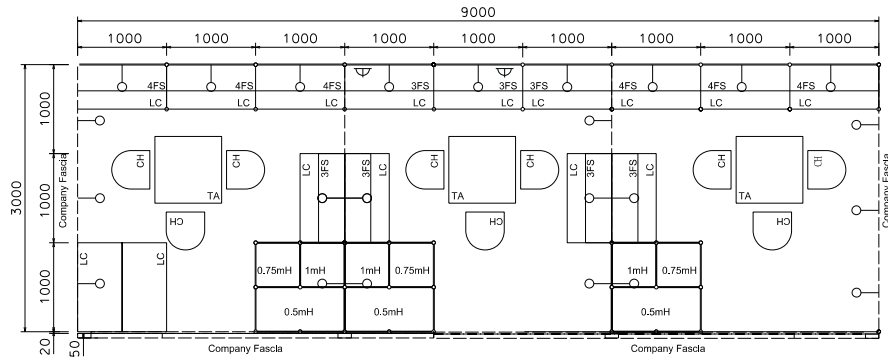

PLAN

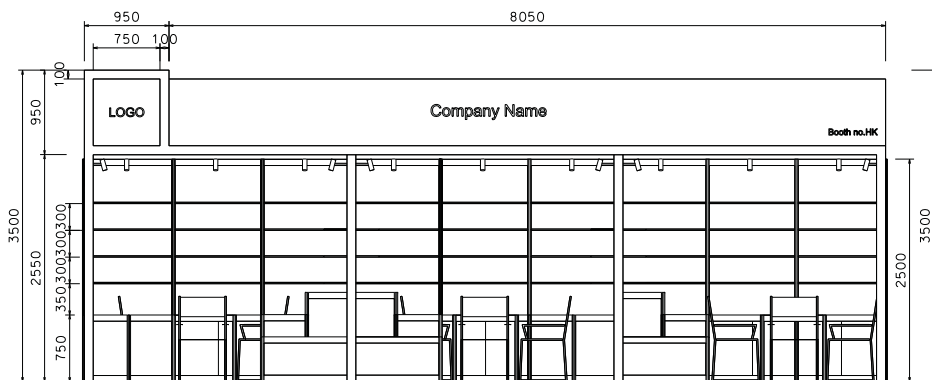

FRONT ELEVATION

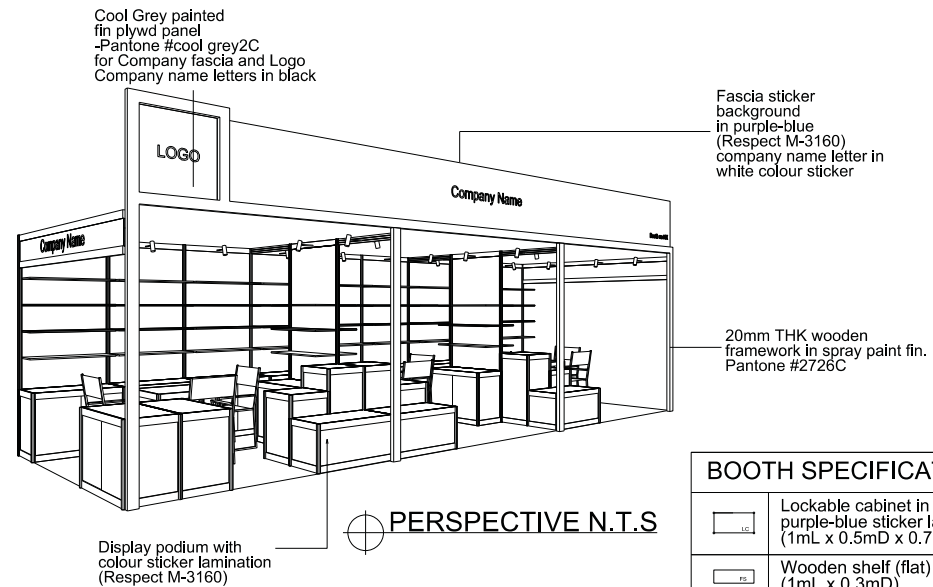

Display podium with colour sticker lamination (Respect M-3160)

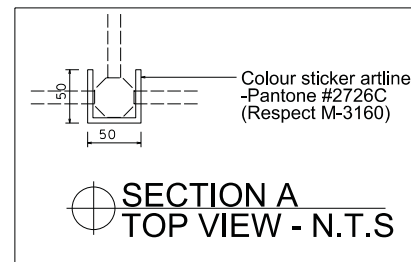

| BOOTH SPECIFICATION | | QTY |
|---------------------|---------------------------------------------------------------------------|-----|
| | Lockable cabinet in purple-blue sticker lamination (1mL x 0.5mD x 0.75mH) | 15 |
| | Wooden shelf (flat) (1mL x 0.3mD) | 45 |
| | 0.5mX 0.5mX 1mH display podium in blue sticker lamination | 3 |
| | 0.5mX 0.5mX 0.75mH display podium in blue sticker lamination | 3 |
| | 0.5mX 1mX 0.5mH display podium in blue sticker lamination | 3 |
| | Square meeting table (0.7m X 0.7m x 0.75mH) | 3 |
| | Black leather chair | 9 |
| | Longarmed spotlight w/23 watt energy saving lamp (yellow) | 24 |
| | 500w Square pin power socket | 3 |
| | Company logo | 1 |

FILE PATH - L:\Local Fair Premium Booth 2011\SD-Layouts\SD-B layout\SD-B-2d\eyout.dgn

*The Hong Kong Trade Development Council reserves the right to change the configuration if necessary.

*如有需要，香港貿易發展局有權更改展台結構。

Premium Booth 9mW x 3mD Right Corner Booth

SD-B-27_ 9mW x 3mD x 3.5mH

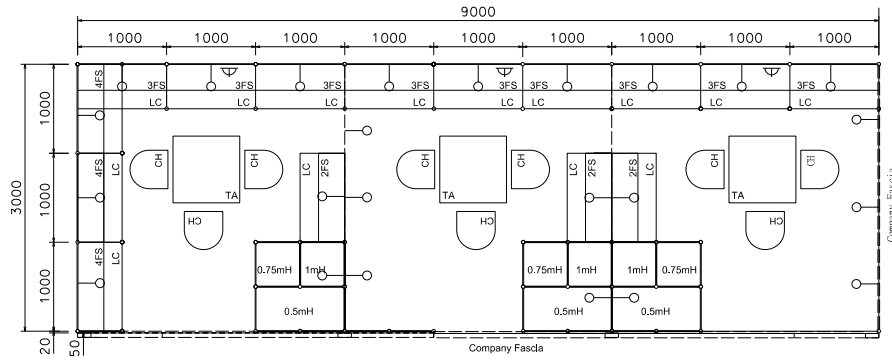

Cool Grey painted
fin plywd panel
-Pantone #cool grey2C
for Company fascia and Logo
Company name letters in black

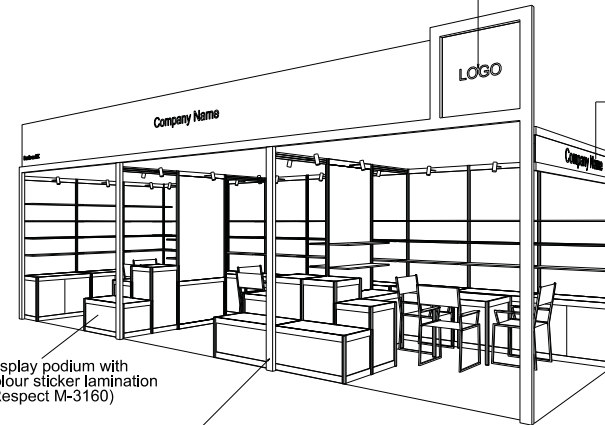

Fascia sticker
background
in purple-blue
(Respect M-3160)
company name letter in
white colour sticker

PLAN

PERSPECTIVE N.T.S

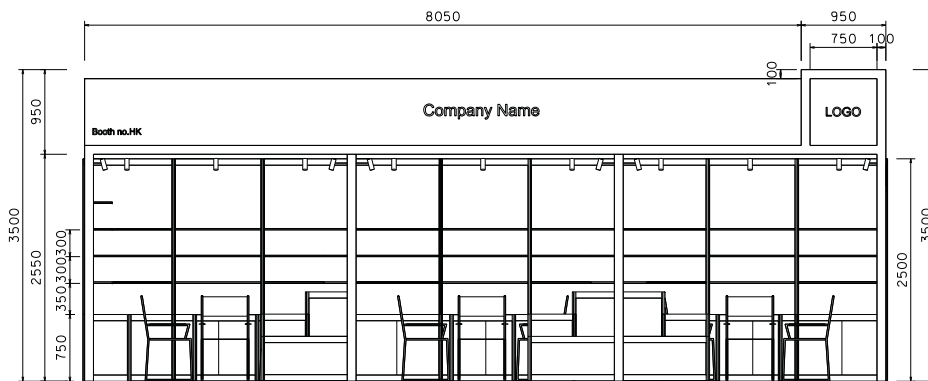

Display podium with
colour sticker lamination
(Respect M-3160)

20mm THK wooden
framework in spray paint fin.
Pantone #2726C

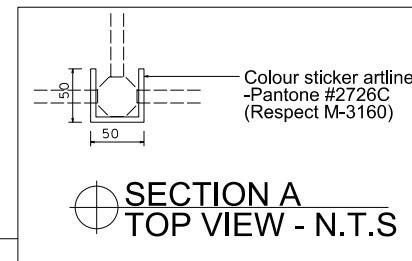

SECTION A
TOP VIEW - N.T.S

| BOOTH SPECIFICATION | | QTY |
|---------------------|---------------------------------------------------------------------------|------|
| | Lockable cabinet in purple-blue sticker lamination (1mL x 0.5mD x 0.75mH) | 14.5 |
| | Wooden shelf (flat) (1mL x 0.3mD) | 45 |
| | 0.5mX 0.5mX 1mH display podium in blue sticker lamination | 3 |
| | 0.5mX 0.5mX 0.75mH display podium in blue sticker lamination | 3 |
| | 0.5mX 1mX 0.5mH display podium in blue sticker lamination | 3 |
| | Square meeting table (0.7m X0.7m x 0.75mH) | 3 |
| | Black leather chair | 9 |
| | Longarmed spotlight w/23 watt energy saving lamp (yellow) | 24 |
| | 500w Square pin power socket | 3 |
| | Company logo | 1 |

*The Hong Kong Trade Development Council reserves the right to change the configuration if necessary.

*如有需要，香港貿易發展局有權更改展台結構。