

Hong Kong Baby Products Fair

香港嬰兒用品展

3M x 5M Deluxe Booth

三米乘五米高級攤位

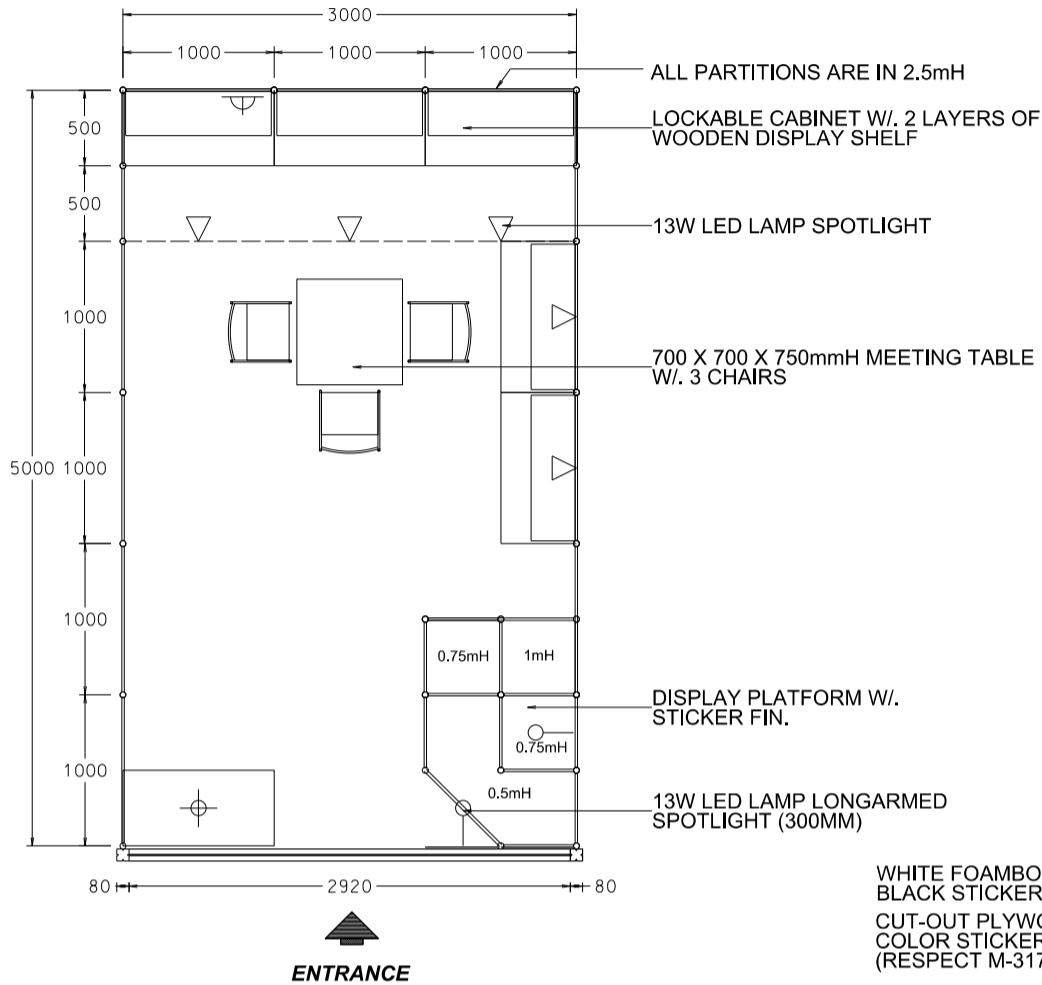

PLAN

CUT-OUT PLYWOOD SHAPE COLOR STICKER LAMINATION (RESPECT M-3164 GREEN)

WHITE FOAMBOARD W/ BLACK STICKER COMPANY NAME

WHITE FOAMBOARD W/ BLACK STICKER COMPANY NAME

CUT-OUT PLYWOOD SHAPE COLOR STICKER LAMINATION (RESPECT M-3178 ORANGE)

CUT-OUT PLYWOOD SHAPE COLOR STICKER LAMINATION (RESPECT M-3148 YELLOW)

CUT-OUT PLYWOOD SHAPE COLOR STICKER LAMINATION (RESPECT M-3178 ORANGE)

CUT-OUT PLYWOOD SHAPE COLOR STICKER LAMINATION (RESPECT M-3164 GREEN)

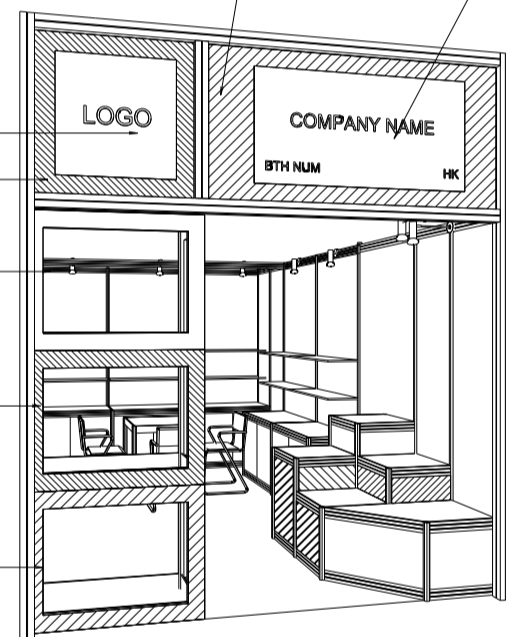

PERSPECTIVE

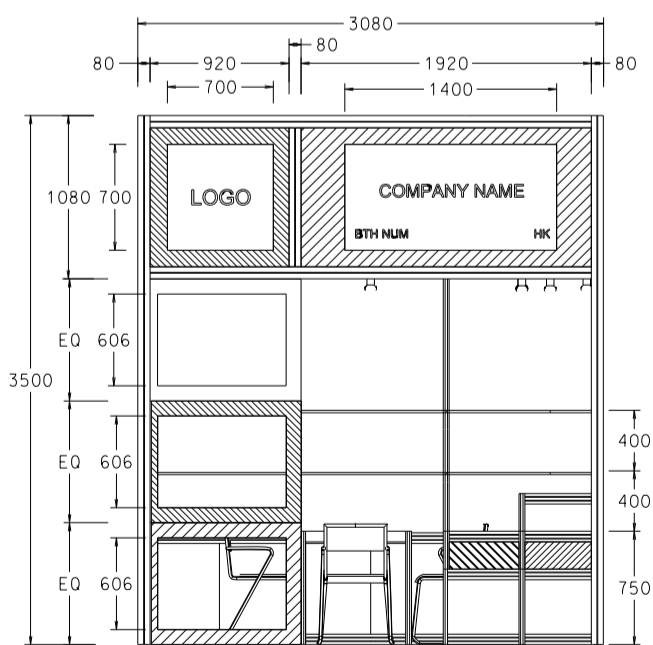

BOOTH SPECIFICATIONS		QTY.
	LOCKABLE CABINET 1000L x 500W x 750H mm	5
	WOODEN DISPLAY SHELF FLAT (1000W X 300D mm)	10
	DISPLAY PLATFORM IN STICKER LAMINATIONS 500 / 750 / 1000mmH	1
	DISPLAY SHOWCASE IN STICKER LAMINATIONS (3 LEVELS) W/ 3 X 7W LED DOWNLIGHT	1
	13W LED LAMP SPOTLIGHT (YELLOW LIGHT)	5
	13W LED LAMP LONGARMED SPOTLIGHT (300MM) (YELLOW LIGHT)	2
	500w SQUARE PIN SOCKET	1
	700W x 700D x 750H mm MEETING TABLE	1
	BLACK LEATHER CHAIR	3
	CEILING BEAM	3M
	COMPANY LOGO	1
	RUBBISH BIN & CARPET (15sqm.)	

Hong Kong Baby Products Fair

香港嬰兒用品展

3M x 5M Deluxe Right Corner Booth

三米乘五米高級右邊角位攤位

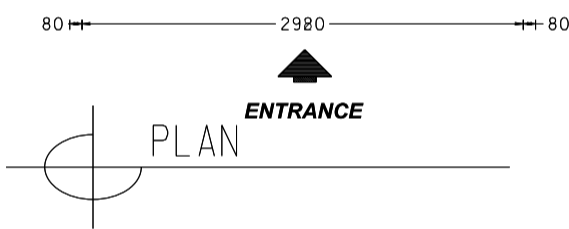
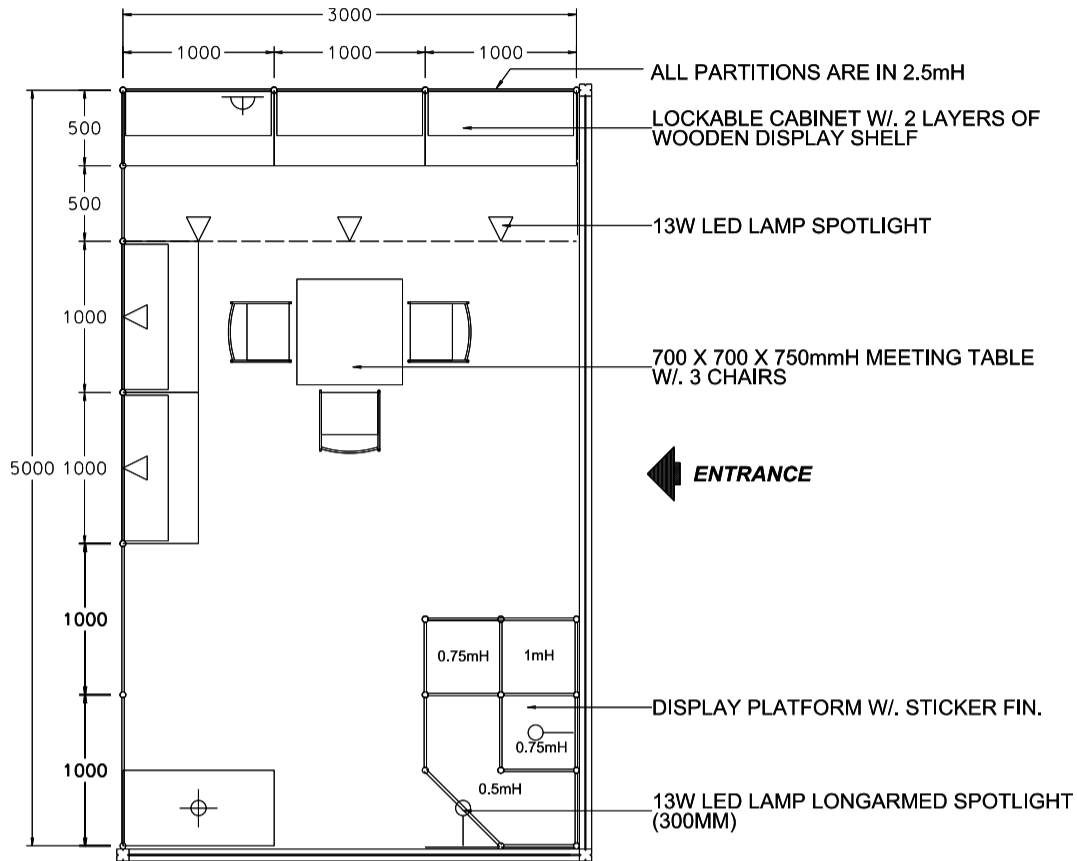

WHITE FOAMBOARD W/ BLACK STICKER COMPANY NAME

CUT-OUT PLYWOOD SHAPE COLOR STICKER LAMINATION (RESPECT M-3164 GREEN)

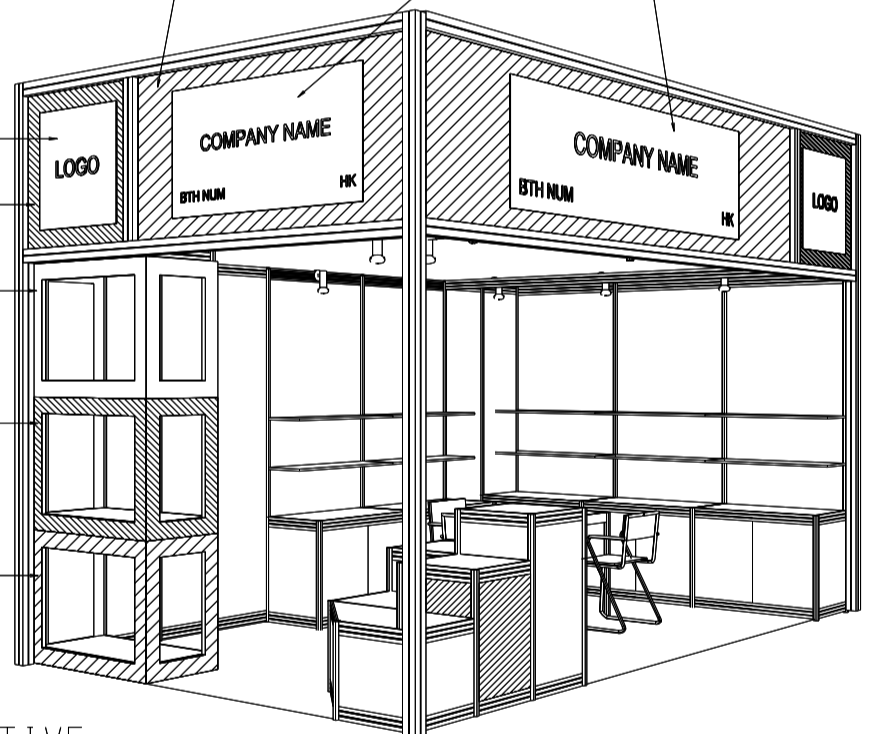

WHITE FOAMBOARD W/ BLACK STICKER COMPANY NAME

CUT-OUT PLYWOOD SHAPE COLOR STICKER LAMINATION (RESPECT M-3178 ORANGE)

CUT-OUT PLYWOOD SHAPE COLOR STICKER LAMINATION (RESPECT M-3148 YELLOW)

CUT-OUT PLYWOOD SHAPE COLOR STICKER LAMINATION (RESPECT M-3178 ORANGE)

CUT-OUT PLYWOOD SHAPE COLOR STICKER LAMINATION (RESPECT M-3164 GREEN)

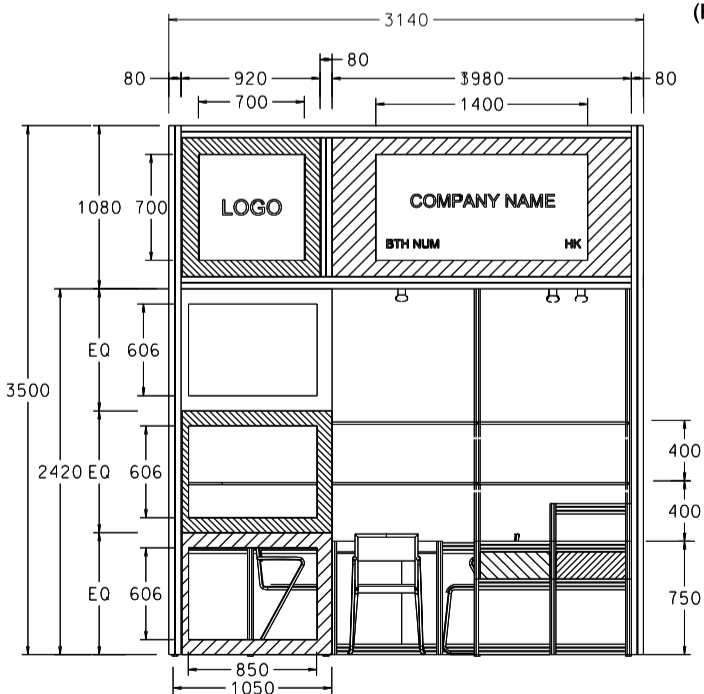

BOOTH SPECIFICATIONS		QTY.
	LOCKABLE CABINET 1000L x 500W x 750H mm	5
	WOODEN DISPLAY SHELF FLAT (1000W X 300D mm)	10
	DISPLAY PLATFORM IN STICKER LAMINATIONS 500 / 750 / 1000mmH	1
	DISPLAY SHOWCASE IN STICKER LAMINATIONS (3 LEVELS) W/ 3 X 7W LED DOWNLIGHT	1
	13W LED LAMP SPOTLIGHT (YELLOW LIGHT)	5
	13W LED LAMP LONGARMED SPOTLIGHT (300MM) (YELLOW LIGHT)	2
	500w SQUARE PIN SOCKET	1
	700W x 700D x 750H mm MEETING TABLE	1
	BLACK LEATHER CHAIR	3
	CEILING BEAM	3M
	COMPANY LOGO	2
	RUBBISH BIN & CARPET (15sqm.)	

Hong Kong Baby Products Fair

香港嬰兒用品展

5M x 3M Deluxe Booth

五米乘三米高級攤位

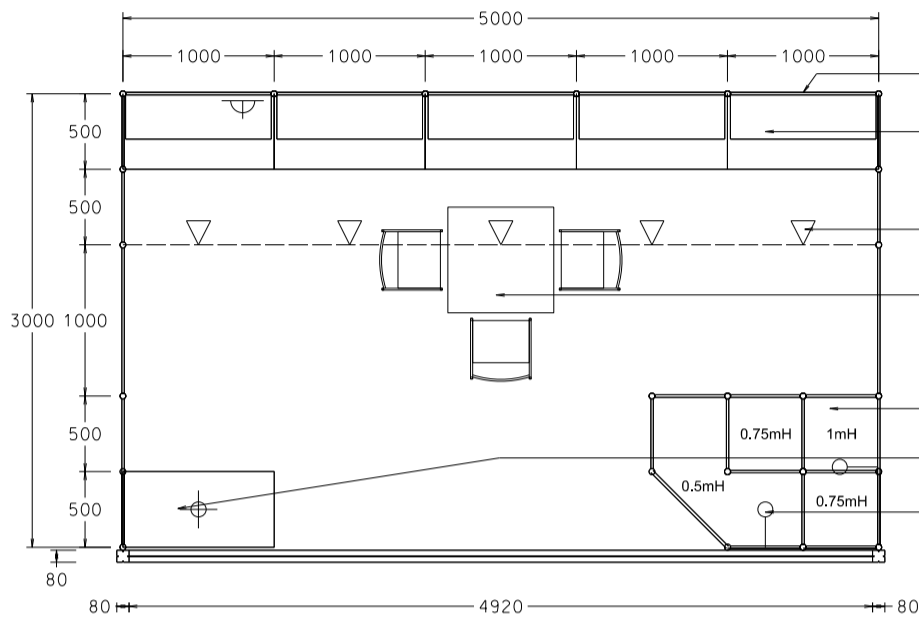

ALL PARTITIONS ARE IN 2.5mH

LOCKABLE CABINET W/. 2 LAYERS OF WOODEN DISPLAY SHELF

13W LED LAMP SPOTLIGHT

700 X 700 X 750mmH MEETING TABLE W/. 3 CHAIRS

DISPLAY PLATFORM W/. STICKER FIN.

DISPLAY SHOWCASE w/. 3 x 7W LED DOWNLIGHT

13W LED LAMP LONGARMED SPOTLIGHT (300MM)

PLAN

ENTRANCE

CUT-OUT PLYWOOD SHAPE COLOR STICKER LAMINATION (RESPECT M-3164 GREEN)

WHITE FOAMBOARD W/. BLACK STICKER COMPANY NAME

WHITE FOAMBOARD W/. BLACK STICKER COMPANY NAME

CUT-OUT PLYWOOD SHAPE COLOR STICKER LAMINATION (RESPECT M-3178 ORANGE)

CUT-OUT PLYWOOD SHAPE COLOR STICKER LAMINATION (RESPECT M-3148 YELLOW)

CUT-OUT PLYWOOD SHAPE COLOR STICKER LAMINATION (RESPECT M-3178 ORANGE)

CUT-OUT PLYWOOD SHAPE COLOR STICKER LAMINATION (RESPECT M-3164 GREEN)

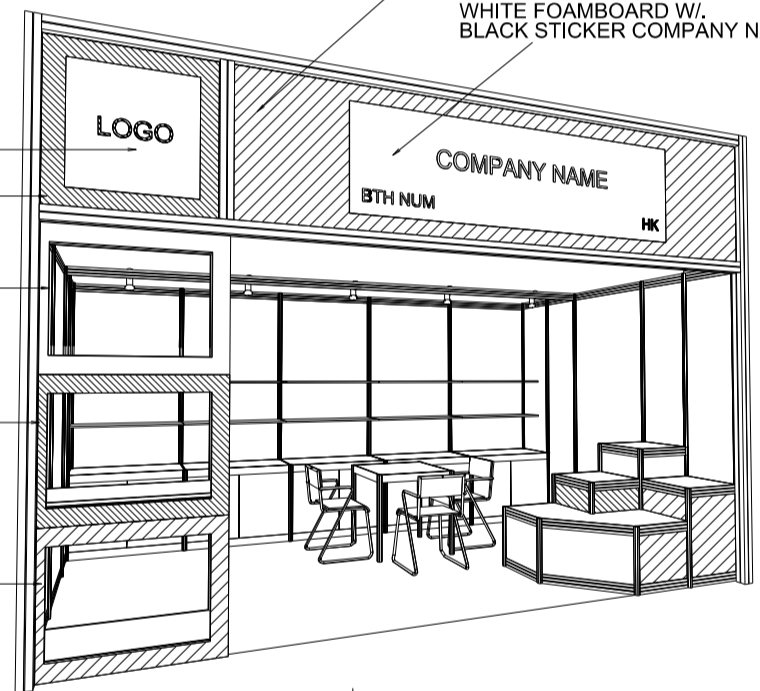

PERSPECTIVE

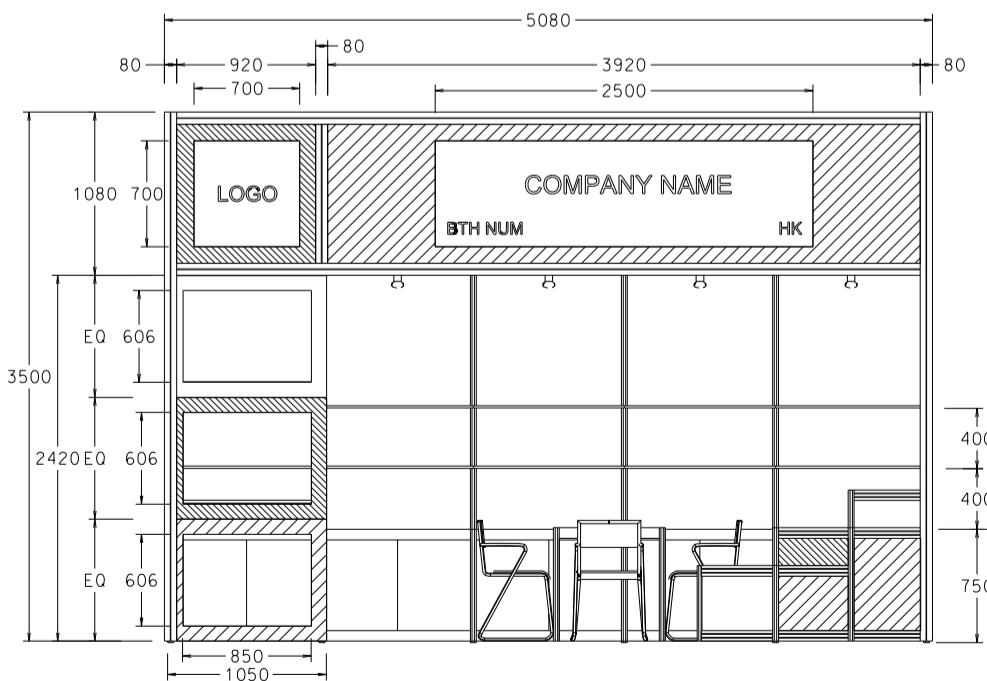

ELEVATION

BOOTH SPECIFICATIONS

QTY.

	LOCKABLE CABINET 1000L x 500W x 750H mm	5
	WOODEN DISPLAY SHELF FLAT (2000W X 300D mm)	2
	WOODEN DISPLAY SHELF FLAT (3000W X 300D mm)	2
	DISPLAY PLATFORM IN STICKER LAMINATIONS 500 / 750 / 1000mmH	1
	DISPLAY SHOWCASE IN STICKER LAMINATIONS (3 LEVELS) W/. 3 X 7W LED DOWNLIGHT	1
	13W LED LAMP SPOTLIGHT (YELLOW LIGHT)	5
	13W LED LAMP LONGARMED SPOTLIGHT (300MM) (YELLOW LIGHT)	2
	500w SQUARE PIN SOCKET	1
	700W x 700D x 750H mm MEETING TABLE	1
	BLACK LEATHER CHAIR	3
	CEILING BEAM	5M
	COMPANY LOGO	1
	RUBBISH BIN & CARPET (15sqm.)	

5M x 3M Deluxe Left Corner Booth

五米乘三米高級左邊角位攤位

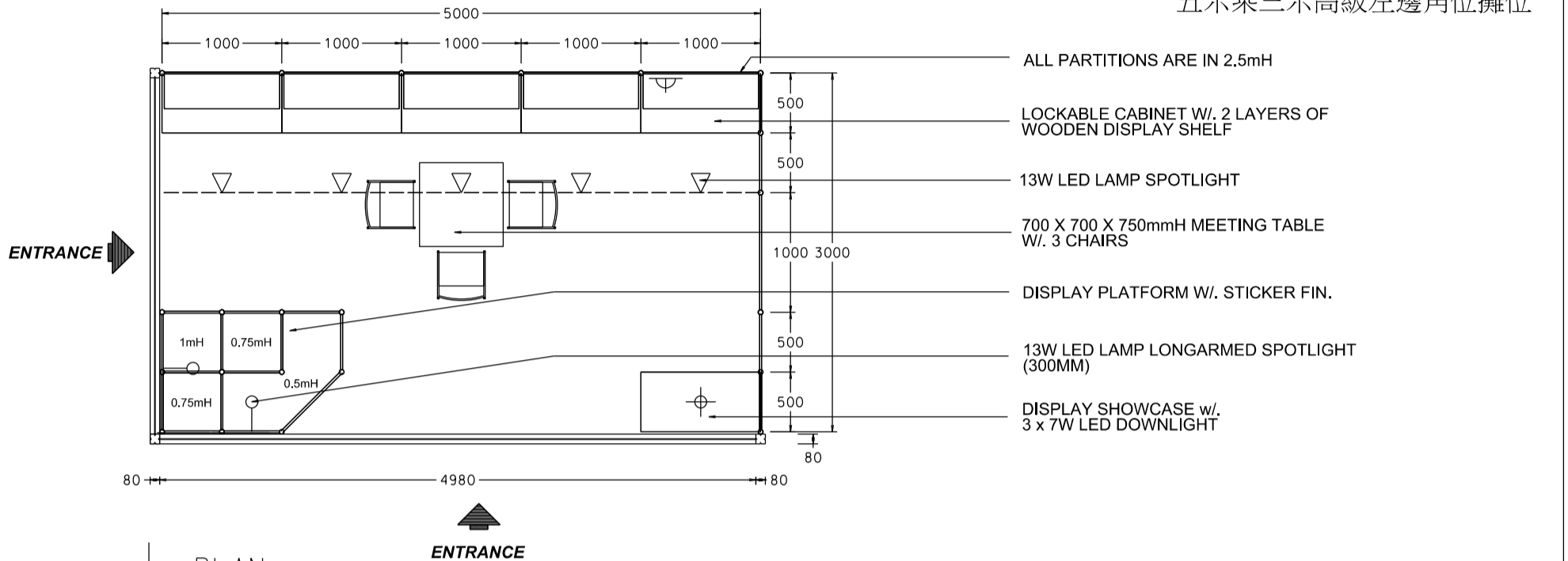

ENTRANCE

WHITE FOAMBOARD W/ BLACK STICKER COMPANY NAME

CUT-OUT PLYWOOD SHAPE COLOR STICKER LAMINATION (RESPECT M-3178 ORANGE)

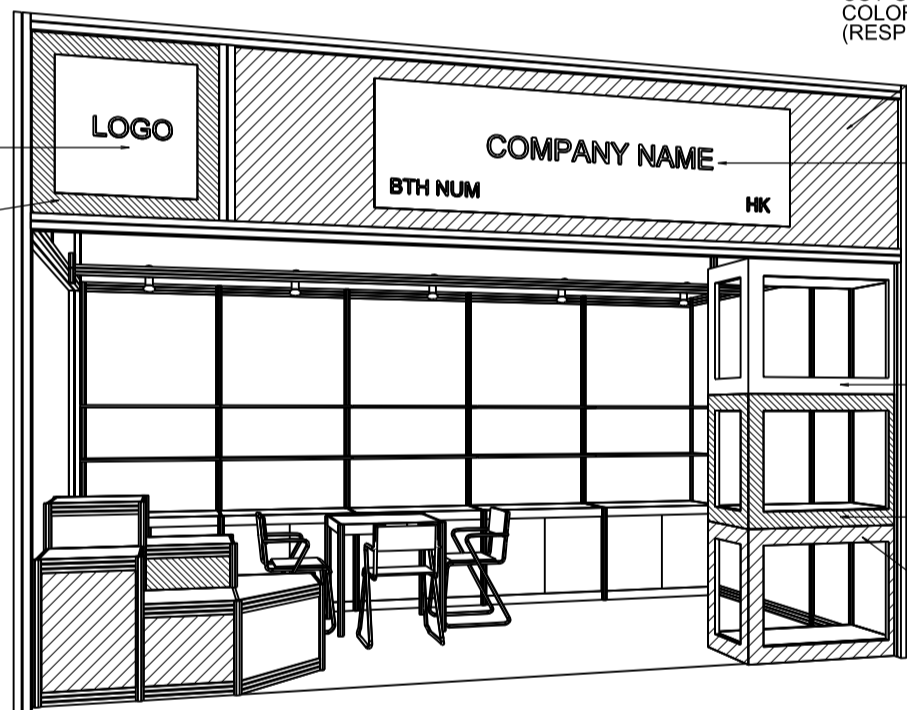

CUT-OUT PLYWOOD SHAPE COLOR STICKER LAMINATION (RESPECT M-3164 GREEN)

WHITE FOAMBOARD W/ BLACK STICKER COMPANY NAME

CUT-OUT PLYWOOD SHAPE COLOR STICKER LAMINATION (RESPECT M-3148 YELLOW)

CUT-OUT PLYWOOD SHAPE COLOR STICKER LAMINATION (RESPECT M-3178 ORANGE)

CUT-OUT PLYWOOD SHAPE COLOR STICKER LAMINATION (RESPECT M-3164 GREEN)

PERSPECTIVE

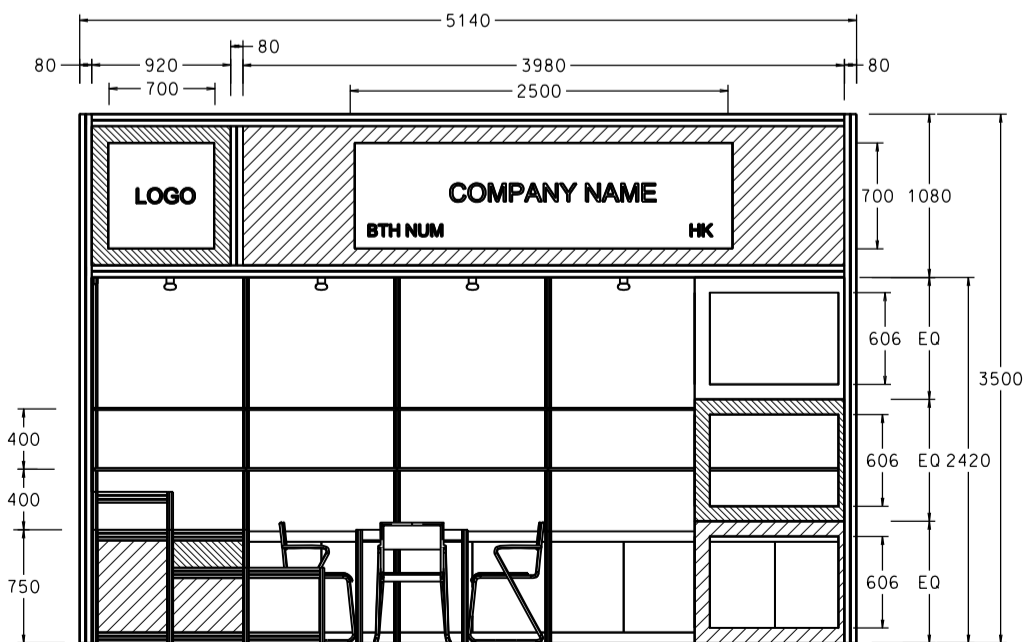

ELEVATION

BOOTH SPECIFICATIONS

QTY.

	LOCKABLE CABINET 1000L x 500W x 750H mm	5
	WOODEN DISPLAY SHELF FLAT (2000W X 300D mm)	2
	WOODEN DISPLAY SHELF FLAT (3000W X 300D mm)	2
	DISPLAY PLATFORM IN STICKER LAMINATIONS 500 / 750 / 1000mmH	1
	DISPLAY SHOWCASE IN STICKER LAMINATIONS (3 LEVELS) W/ 3 X 7W LED DOWNLIGHT	1
	13W LED LAMP SPOTLIGHT (YELLOW LIGHT)	5
	13W LED LAMP LONGARMED SPOTLIGHT (300MM) (YELLOW LIGHT)	2
	500w SQUARE PIN SOCKET	1
	700W x 700D x 750H mm MEETING TABLE	1
	BLACK LEATHER CHAIR	3
	CEILING BEAM	5M
	COMPANY LOGO	2
	RUBBISH BIN & CARPET (15sqm.)	

5M x 3M Deluxe Right Corner Booth

五米乘三米高級右邊角位攤位

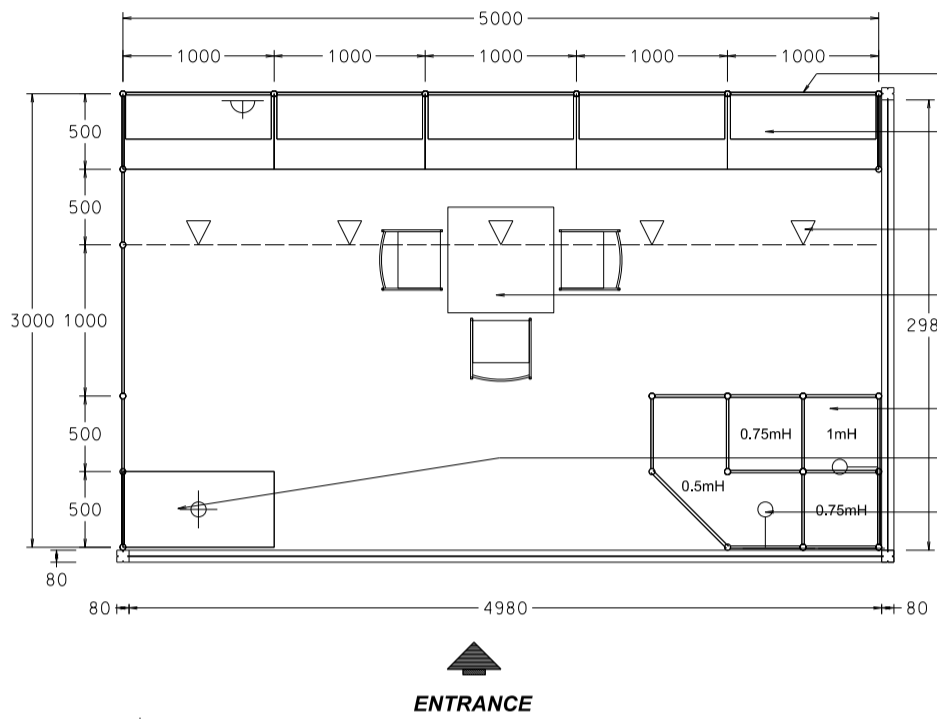

PLAN

- ALL PARTITIONS ARE IN 2.5mH
- LOCKABLE CABINET W/ 2 LAYERS OF WOODEN DISPLAY SHELF
- 13W LED LAMP SPOTLIGHT
- 700 X 700 X 750mmH MEETING TABLE W/ 3 CHAIRS
- ENTRANCE
- DISPLAY PLATFORM W/ STICKER FIN.
- DISPLAY SHOWCASE w/ 3 x 7W LED DOWNLIGHT
- 13W LED LAMP LONGARMED SPOTLIGHT (300MM)

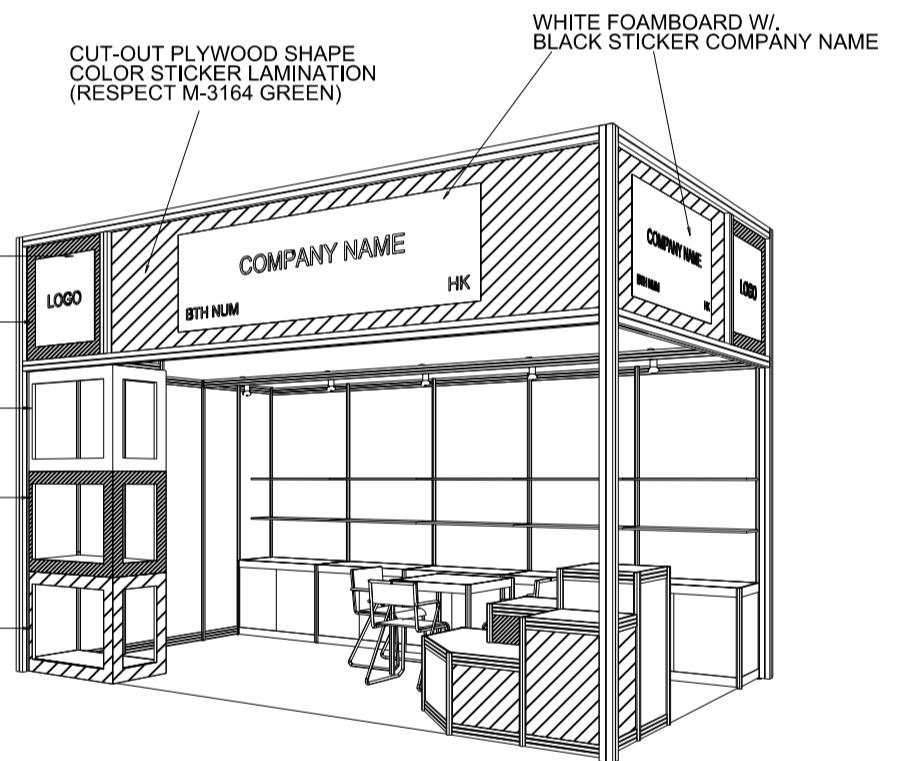

- WHITE FOAMBOARD W/ BLACK STICKER COMPANY NAME
- CUT-OUT PLYWOOD SHAPE COLOR STICKER LAMINATION (RESPECT M-3178 ORANGE)
- CUT-OUT PLYWOOD SHAPE COLOR STICKER LAMINATION (RESPECT M-3148 YELLOW)
- CUT-OUT PLYWOOD SHAPE COLOR STICKER LAMINATION (RESPECT M-3178 ORANGE)
- CUT-OUT PLYWOOD SHAPE COLOR STICKER LAMINATION (RESPECT M-3164 GREEN)

PERSPECTIVE

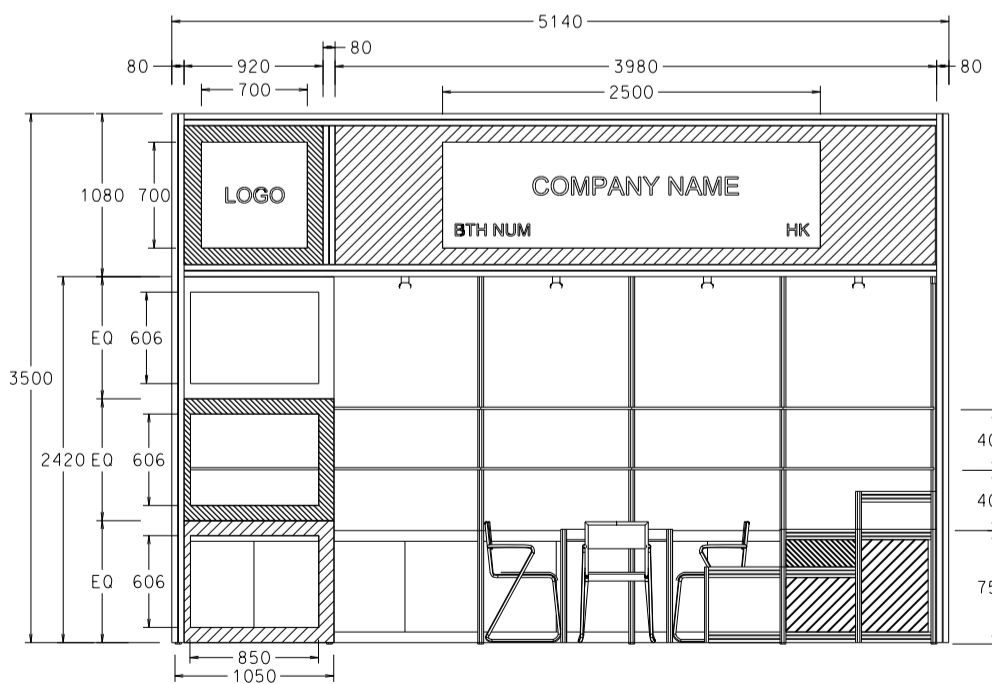

ELEVATION

BOOTH SPECIFICATIONS		QTY.
	LOCKABLE CABINET 1000L x 500W x 750H mm	5
	WOODEN DISPLAY SHELF FLAT (2000W X 300D mm)	2
	WOODEN DISPLAY SHELF FLAT (3000W X 300D mm)	2
	DISPLAY PLATFORM IN STICKER LAMINATIONS 500 / 750 / 1000mmH	1
	DISPLAY SHOWCASE IN STICKER LAMINATIONS (3 LEVELS) W/ 3 X 7W LED DOWNLIGHT	1
	13W LED LAMP SPOTLIGHT (YELLOW LIGHT)	5
	13W LED LAMP LONGARMED SPOTLIGHT (300MM) (YELLOW LIGHT)	2
	500w SQUARE PIN SOCKET	1
	700W x 700D x 750H mm MEETING TABLE	1
	BLACK LEATHER CHAIR	3
	CEILING BEAM	5M
	COMPANY LOGO	2
	RUBBISH BIN & CARPET (15sqm.)	

5M x 3M Deluxe Booth (FOR GARMENT)

五米乘三米高級攤位

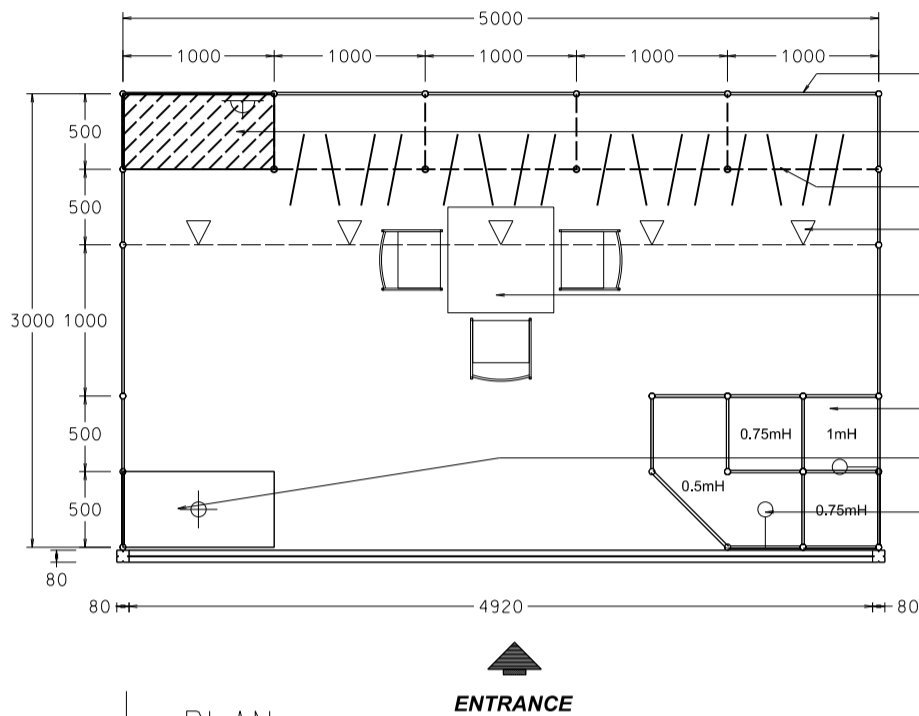

- ALL PARTITIONS ARE IN 2.5mH
- LOCKABLE CABINET
- GARMENT RAIL
- 13W LED LAMP SPOTLIGHT
- 700 X 700 X 750mmH MEETING TABLE W/ 3 CHAIRS
- DISPLAY PLATFORM W/ STICKER FIN.
- DISPLAY SHOWCASE w/ 3 x 7W LED DOWNLIGHT
- 13W LED LAMP LONGARMED SPOTLIGHT (300MM)

CUT-OUT PLYWOOD SHAPE
COLOR STICKER LAMINATION
(RESPECT M-3164 GREEN)

WHITE FOAMBOARD W/
BLACK STICKER COMPANY NAME

WHITE FOAMBOARD W/
BLACK STICKER COMPANY NAME

CUT-OUT PLYWOOD SHAPE
COLOR STICKER LAMINATION
(RESPECT M-3178 ORANGE)

CUT-OUT PLYWOOD SHAPE
COLOR STICKER LAMINATION
(RESPECT M-3148 YELLOW)

CUT-OUT PLYWOOD SHAPE
COLOR STICKER LAMINATION
(RESPECT M-3178 ORANGE)

CUT-OUT PLYWOOD SHAPE
COLOR STICKER LAMINATION
(RESPECT M-3164 GREEN)

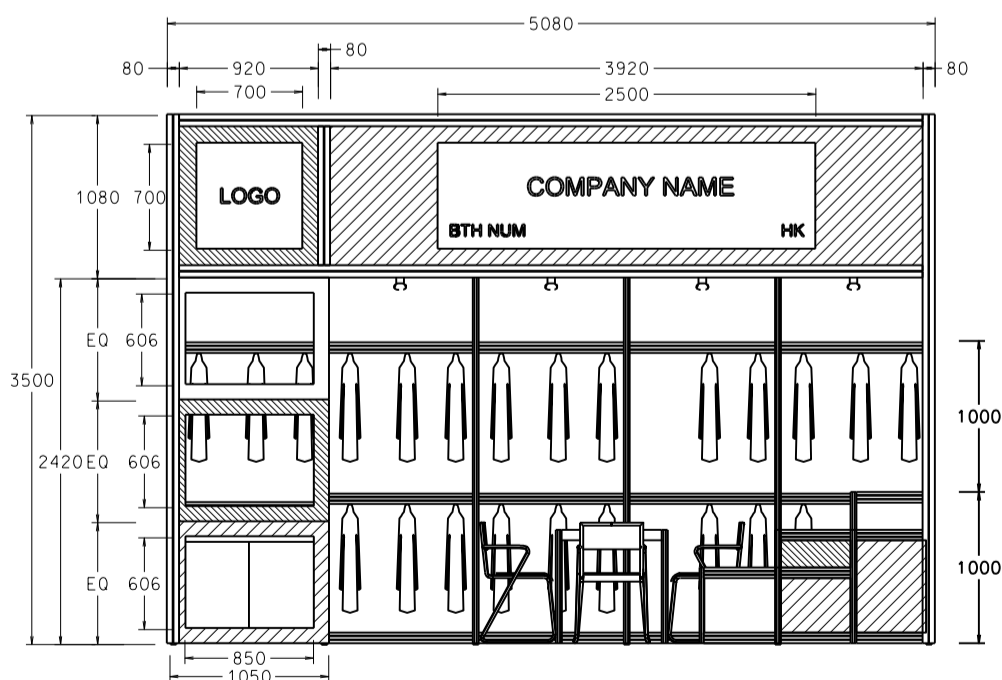
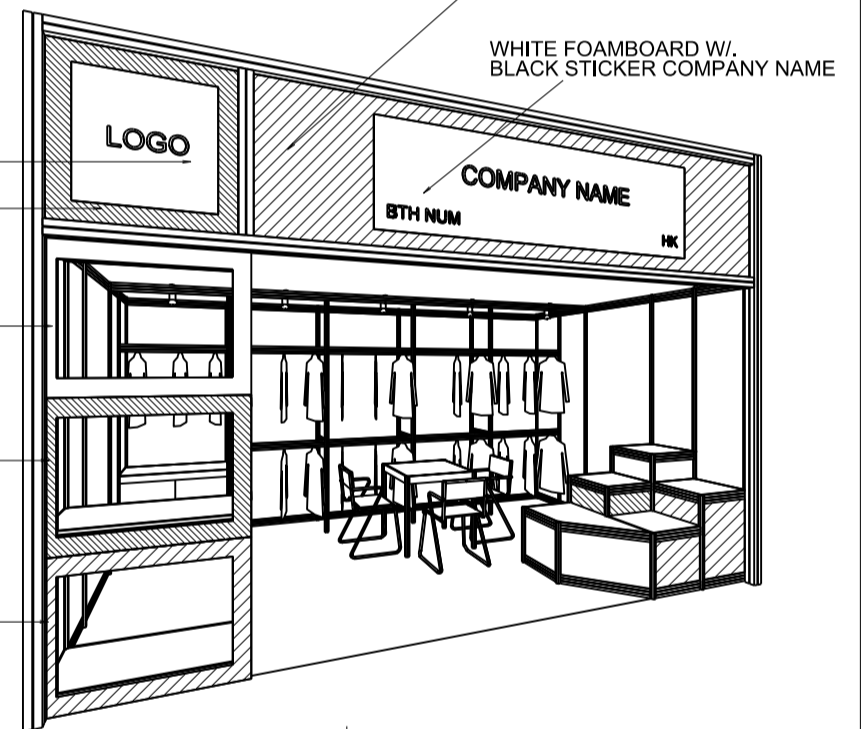

BOOTH SPECIFICATIONS		QTY.
	LOCKABLE CABINET 1000L x 500W x 750H mm	1
	1mL GARMENT RAIL	9
	DISPLAY PLATFORM IN STICKER LAMINATIONS 500 / 750 / 1000mmH	1
	DISPLAY SHOWCASE IN STICKER LAMINATIONS (3 LEVELS) W/ 3 X 7W LED DOWNLIGHT	1
	13W LED LAMP SPOTLIGHT (YELLOW LIGHT)	5
	13W LED LAMP LONGARMED SPOTLIGHT (300MM) (YELLOW LIGHT)	2
	500w SQUARE PIN SOCKET	1
	700W x 700D x 750H mm MEETING TABLE	1
	BLACK LEATHER CHAIR	3
	CEILING BEAM	5M
	COMPANY LOGO	1
	RUBBISH BIN & CARPET (15sqm.)	

Hong Kong Baby Products Fair

香港嬰兒用品展

5M x 3M Deluxe Left Corner Booth (FOR GARMENT)

五米乘三米高級左邊角位攤位

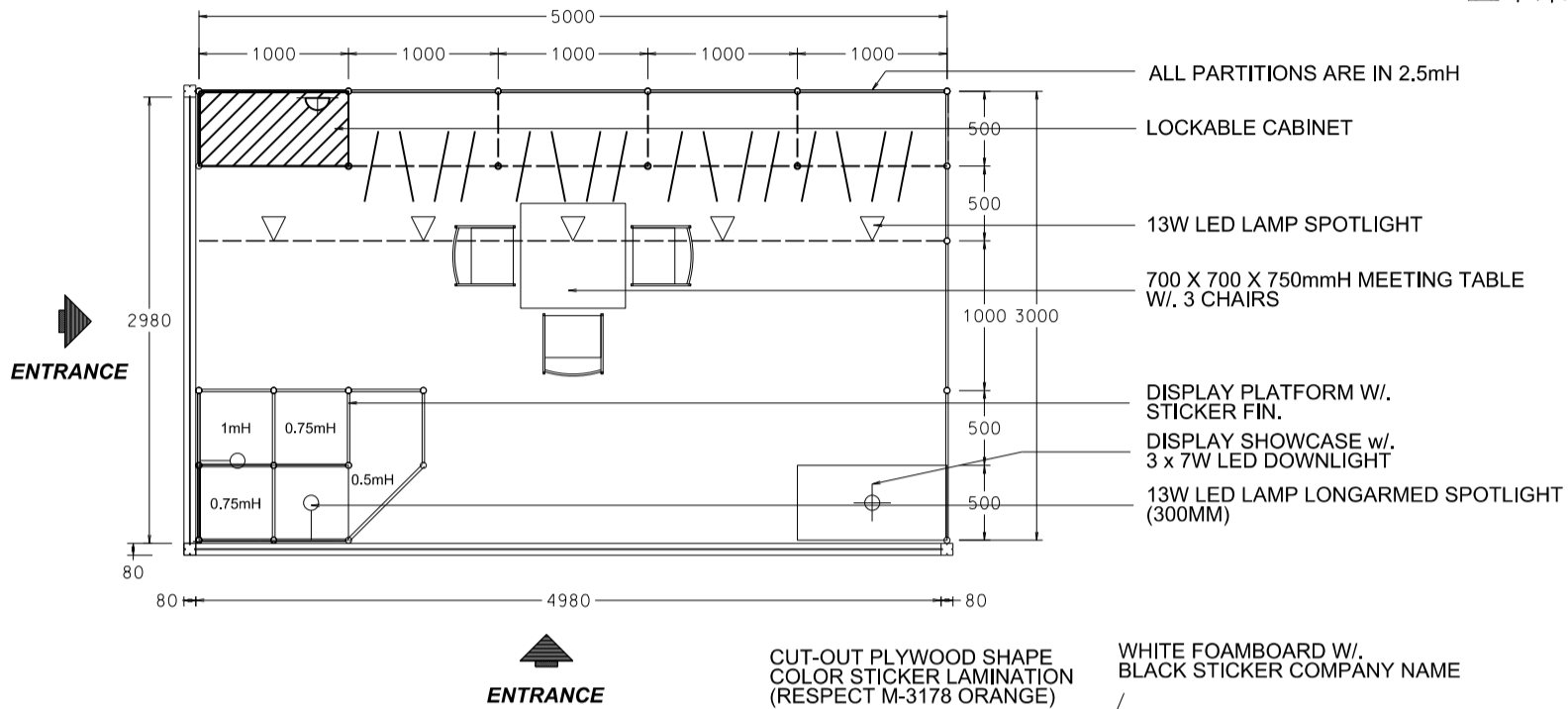

PLAN

CUT-OUT PLYWOOD SHAPE COLOR STICKER LAMINATION (RESPECT M-3178 ORANGE)

WHITE FOAMBOARD W/ BLACK STICKER COMPANY NAME

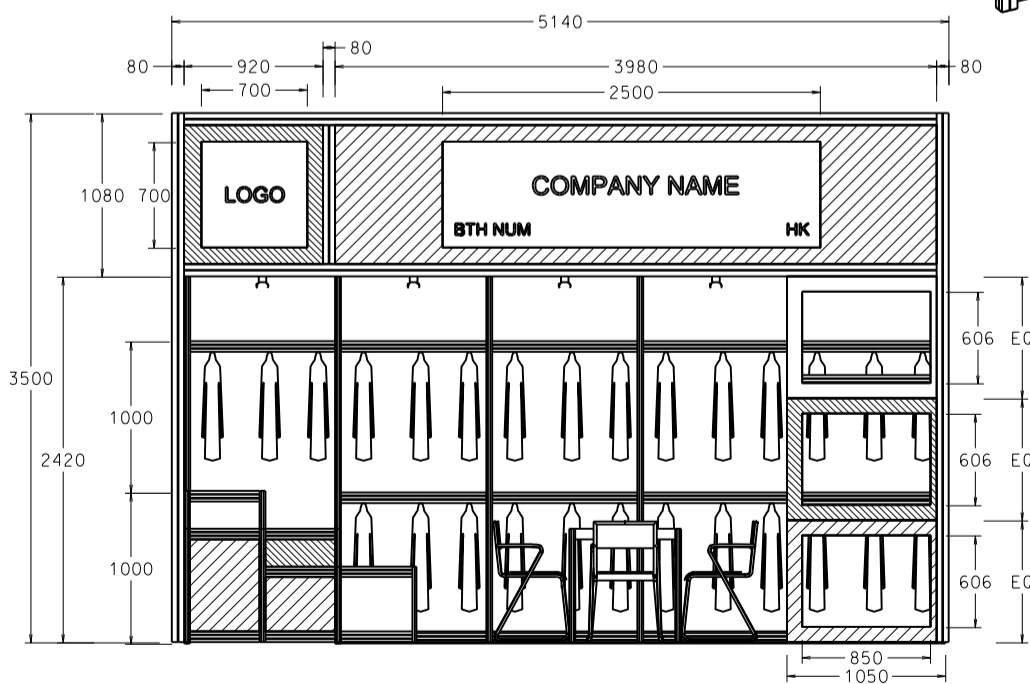
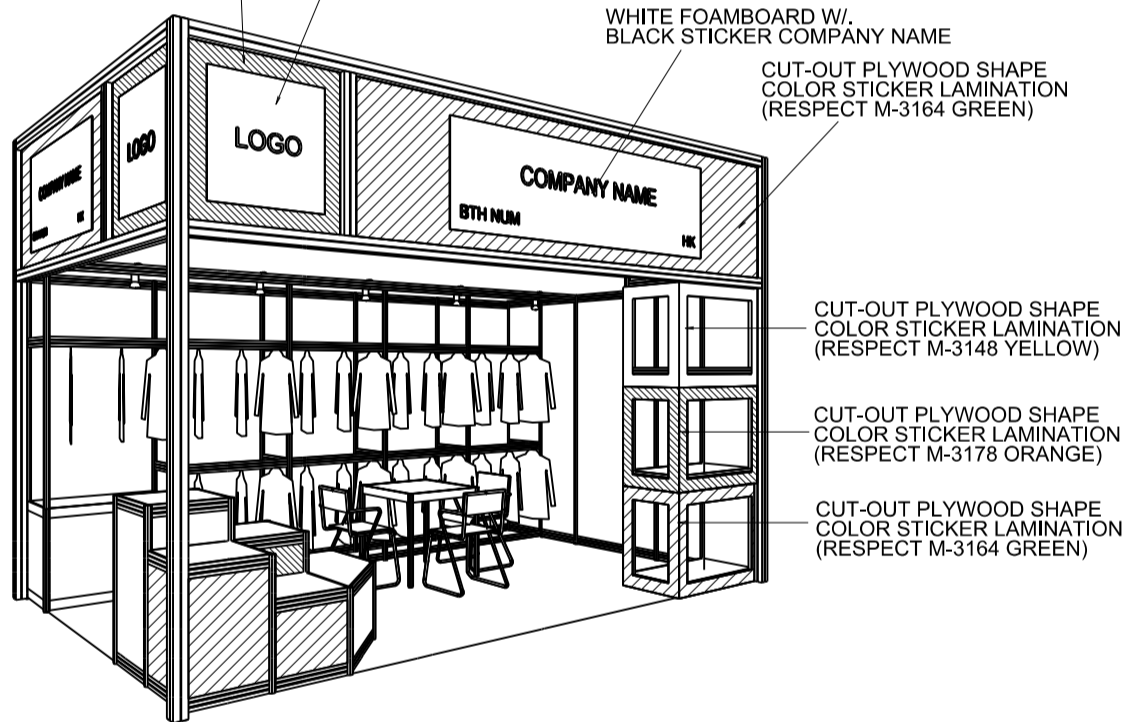

BOOTH SPECIFICATIONS		QTY.
	LOCKABLE CABINET 1000L x 500W x 750H mm	1
	1mL GARMENT RAIL	9
	DISPLAY PLATFORM IN STICKER LAMINATIONS 500 / 750 / 1000mmH	1
	DISPLAY SHOWCASE IN STICKER LAMINATIONS (3 LEVELS) W/ 3 X 7W LED DOWNLIGHT	1
	13W LED LAMP SPOTLIGHT (YELLOW LIGHT)	5
	13W LED LAMP LONGARMED SPOTLIGHT (300MM) (YELLOW LIGHT)	2
	500w SQUARE PIN SOCKET	1
	700W x 700D x 750H mm MEETING TABLE	1
	BLACK LEATHER CHAIR	3
	CEILING BEAM	5M
	COMPANY LOGO	2
	RUBBISH BIN & CARPET (15sqm.)	

*The Hong Kong Trade Development Council reserves the right to change the configuration if necessary.

*如有需要，香港貿易發展局有權更改攤位結構。

5M x 3M Deluxe Right Corner Booth (FOR GARMENT)

五米乘三米高級右邊角位攤位

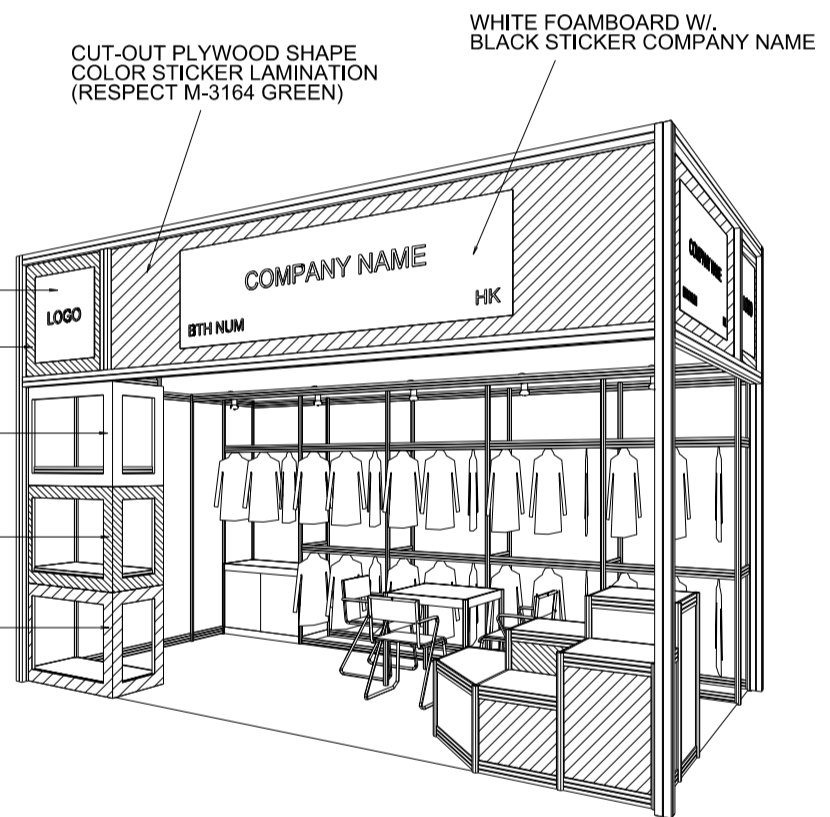
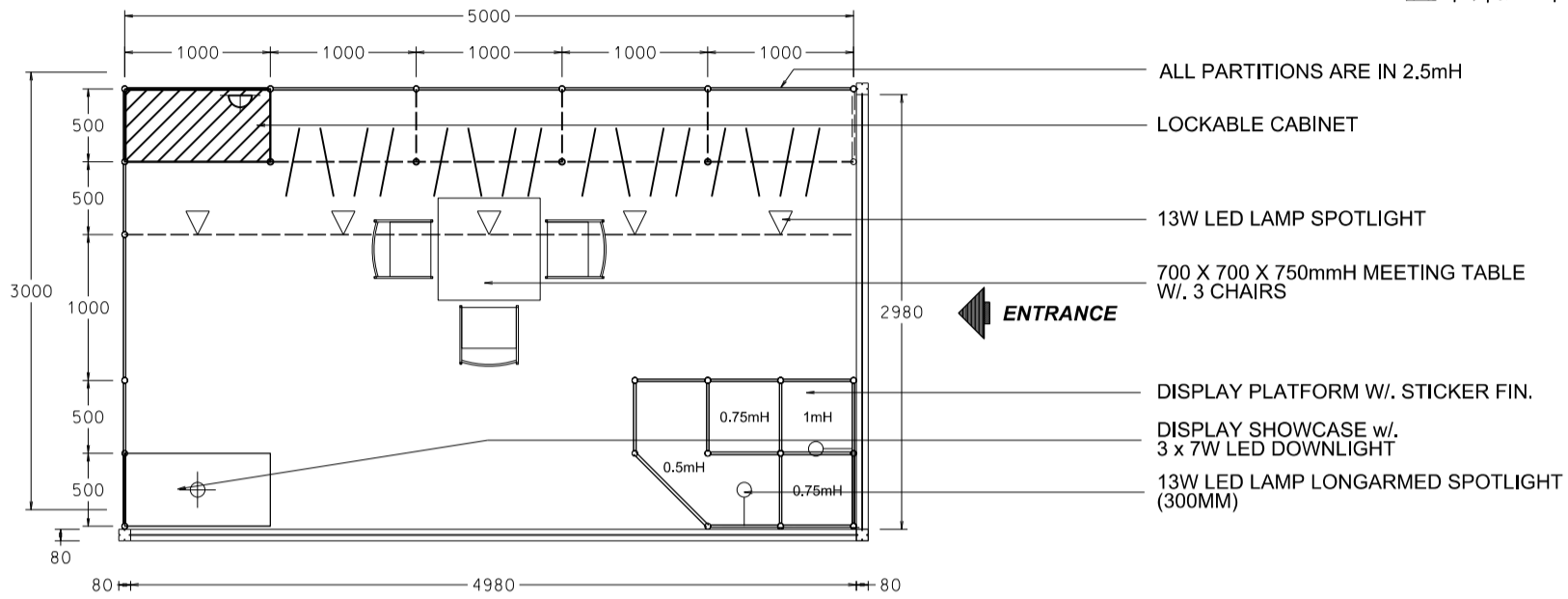

- WHITE FOAMBOARD W/. BLACK STICKER COMPANY NAME
- CUT-OUT PLYWOOD SHAPE COLOR STICKER LAMINATION (RESPECT M-3178 ORANGE)
- CUT-OUT PLYWOOD SHAPE COLOR STICKER LAMINATION (RESPECT M-3148 YELLOW)
- CUT-OUT PLYWOOD SHAPE COLOR STICKER LAMINATION (RESPECT M-3178 ORANGE)
- CUT-OUT PLYWOOD SHAPE COLOR STICKER LAMINATION (RESPECT M-3164 GREEN)

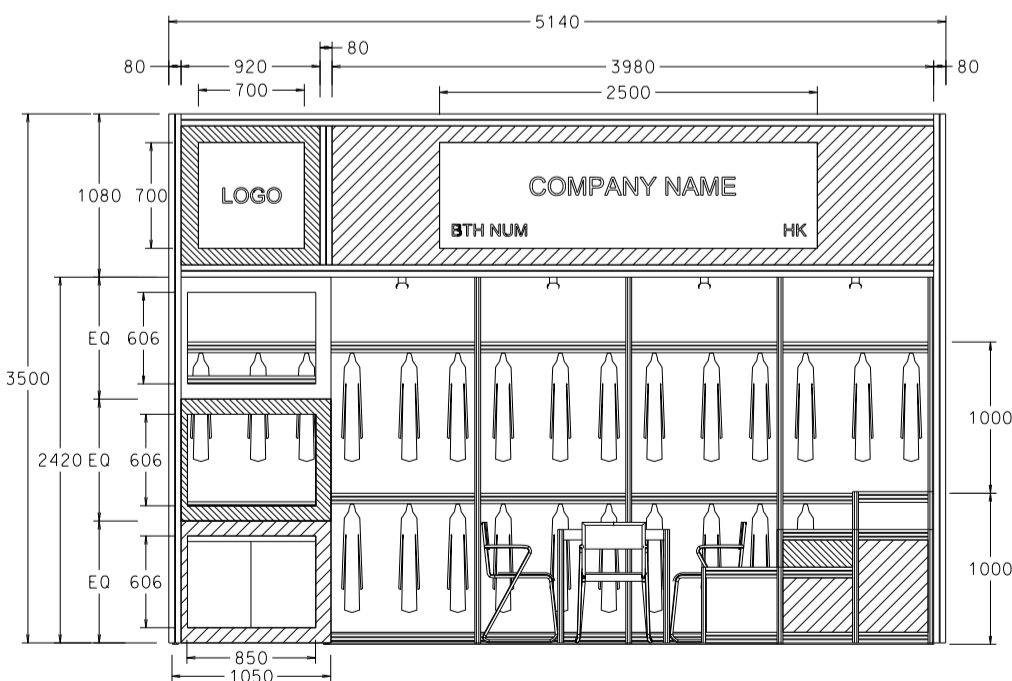

BOOTH SPECIFICATIONS		QTY.
	LOCKABLE CABINET 1000L x 500W x 750H mm	1
	1mL GARMENT RAIL	9
	DISPLAY PLATFORM IN STICKER LAMINATIONS 500 / 750 / 1000mmH	1
	DISPLAY SHOWCASE IN STICKER LAMINATIONS (3 LEVELS) W/. 3 X 7W LED DOWNLIGHT	1
	13W LED LAMP SPOTLIGHT (YELLOW LIGHT)	5
	13W LED LAMP LONGARMED SPOTLIGHT (300MM) (YELLOW LIGHT)	2
	500w SQUARE PIN SOCKET	1
	700W x 700D x 750H mm MEETING TABLE	1
	BLACK LEATHER CHAIR	3
	CEILING BEAM	5M
	COMPANY LOGO	2
	RUBBISH BIN & CARPET (15sqm.)	